

User Manual

Lobby Camera Phone DRC-GUC/RF1



- Thank you for purchasing COMMAX products.
- Please carefully read this User's Guide (in particular, precautions for safety) before using a product and follow instructions to use a product exactly.
- The company is not responsible for any safety accidents caused by abnormal operation of the product.



Table of Contents

1. Greeting	1
2. Safety Warning & Caution	2
3. Parts	4
4. Password type	8
5. How to input Password	9
6. Check house Password	12
7. Set building Number and ID to Lobby panel	13
8. RF card key appliances	15
9. Door release by internal information forwarding to SecuMAX way	23
10. Door opening hours setting	24
11. Line-by-line call function Setting	25
12. Automatic calling function of guard station configuration	26
13. Call Tones selection	27
14. Setting the Number of Call Ring Repetitions	28
15. Door release by external information forwarding to SecuMAX way	29
16. Set to be forced opening the Main Entrance door by SecuMAX	30
17. Setting the time to trigger the notice to be forced door forwarding to SecuMAX	31
18. Selecting the Wiring Method	32
19. Video Out Impedance Adjustment Setting	33
20. Registration of Household Unit Number	34
21. Checking Videophone Status of Household Units	36
22. Setting the Keypad LED Option	38
23. Activation of Electronic Key (Password) Function	39
24. Setting the Volume of Voice and Beep Sound	40
25. Method of name data sending	41
26. How to receive the name of the data	42
27. Setting the door release by building password	43
28. When you want to call a household	45
29. When you want to call a Guard Station	46
30. Door Release by Unit Password	46
31. Supplement (summary of various programs)	47
32. Wiring Information	49
33. Miscellaneous	53
34. Part list	53
35. Specifications and Features	53
36. RF-ID Model (Optional)	54











1. Greeting

- * Thank you for purchasing a COMMAX product
- * This product is a high tech Main Entrance interphone that supports electronic
Please read this manual carefully.













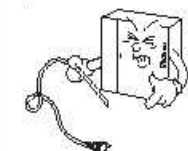



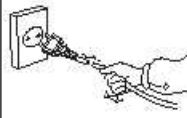





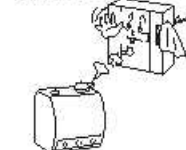

2. Safety Warning & Caution

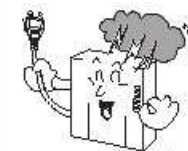
Please follow the things described below in order to prevent any danger or property damage.

	Warning	It may cause a serious damage or injury if violated.		Prohibition.
	Caution	It may cause a minor damage or injury if violated.		No disassembly
				No touch
				Must follow strictly.
				Shows plugging out the power cord without an exception
				Shows the warning and caution for an electric shock.
				Shows the warning and caution for a fire.

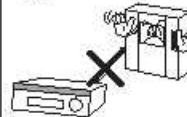
Warning

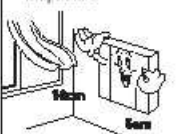
Power & Installation

<p>Please don't use several products at the same time on one power socket.</p> <p>- It may cause a fire due to an abnormal overheating.</p>  <p>   </p> <p>Prohibition Fire</p>	<p>Please don't bend the power cable excessively or it may cause an electric shock.</p> <p>- fire when using a damaged power cable.</p>  <p>    </p> <p>Prohibition Electric shock Fire</p>	<p>Please don't handle the power cable with a wet hand.</p> <p>- It may cause an electric shock.</p>  <p>   </p> <p>Prohibition Fire</p>	<p>Please plug out the power cable from the socket when not using it for a long period of time.</p> <p>- It may shorten the product lifespan or cause a fire.</p>  <p>   </p> <p>Recycle Fire</p>
<p>Please don't install the product in the place where there is much oil, smoke or humidity.</p> <p>- It may cause an electric shock or fire.</p>  <p>    </p> <p>Prohibition Electric shock Fire</p>	<p>Please don't install the product with the lightning and thunder.</p> <p>- It may cause an electric shock or fire.</p>  <p>    </p> <p>Prohibition Electric shock Fire</p>	<p>Please don't use and connect this product with other products with different rated voltage.</p> <p>- It may cause a disorder or fire.</p>  <p>   </p> <p>Prohibition Fire</p>	<p>When installing the product that generates heat, please install the product away from the wall (10cm) for the ventilation.</p> <p>- It may cause a fire due to the increased internal temperature.</p>  <p>   </p> <p>Prohibition Fire</p>

Warning

Cleaning & Use

Please don't disassemble, repair or rebuild this product arbitrarily (please contact the service center if a repair is needed).

· It may cause an electric shock or fire.



If an abnormal sound, burning smell or smoke is coming out of the product, please plug out the power cable and contact a service center.

· It may cause an electric shock or fire.



Please don't insert any metallic or burnable materials into the ventilation hole.

· It may cause an electric shock or fire.

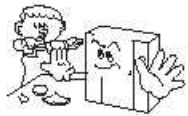

Please use only the designated batteries for the products of using DC power.

· It may cause an electric shock or fire.



Caution

Power & Installation

Please plug the power cable firmly into the inner end.

· It may cause a fire.



Please hold the plug tightly when unplugging the power cable (a part of the copper wire may be disconnected if the grabbing is only made on the cord when pulling out the cable).

· It may cause an electric shock or fire.



When connecting the power cables after cutting the cable, please install the product with power off.

· It may cause an electric shock or fire.



When installing the product, please fix it firmly while using the wall-mounting unit and screws.

· It may cause an injury from the falling object.

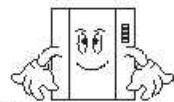

Please be careful when using an AC circuit breaker since there is a possibility of an electric shock.



Please check the use voltage and current for the DC-only products and use the appropriate rectifier.

· It may cause a fire.



Please avoid direct rays of the sun or heating devices at a time of installation.

· It may cause a fire.



Please don't install the product on an unstable place or small support board.

· It may cause an injury if it falls down while in use.

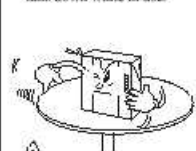

Cleaning & Use

When cleaning the product, please rub it with a soft and dry cloth after plugging out the power cable. (Please don't use any chemical products such as wax, benzene, alcohol or cleanser.)



Please don't drop the product on the ground and don't apply a shock.

· It may cause a failure.

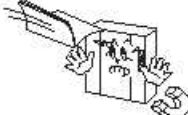

Please use the designated connection cable within the maximum calling distance designated for the product.

· It may reduce the product performance.



3. Parts

3-1. The name of parts

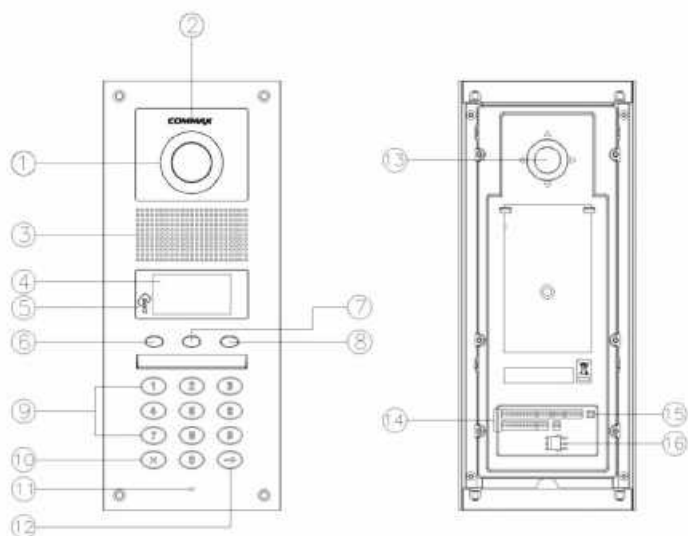

NO.	Description	NO.	Description
1	Camera	9	Number button
2	Night Lamp	10	Cancel Button
3	Speaker	11	C-MIC
4	OLED Display	12	Electric Key Button
5	RFID card receiver	13	Camera angle
6	Name Searching button / Menu Page Button	14	Line connecting button
		15	Reset Button
7	Up & Down scroll button/ Program Button	16	Circuit Connect Switch
8	Call Button		

3-2. Important function

- * Starting OLED display (Power ON OLED display)



- * RF/ID Receiver ③(Optional)

When open door by wireless card key, please tag it to this points.(See bellow photo).

"Open door" message and Icon will be displayed in OLED.

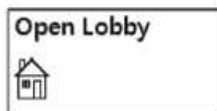

- * Call Button ⑧(E : Press)

Call unit (House).



- * Program button ⑦(P : Program)

Call program menu button.

(Press and hold over 5 sec, then menu will be activated)

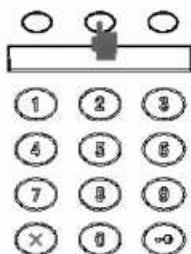

PDF Compressor Free Version

- * Name searching button ⑥(S : Search)

Tenants name searching button.



- * Electric key button ⑫(K : Key)

Open door by Password Number.

(Deactivate Password LOCK function only.)

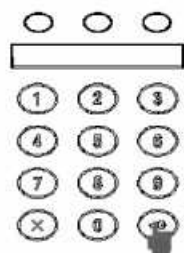

- * Cancel button ⑩(X : Cancel)

When user wants to cancel function, press it.

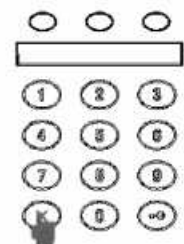

- * Reset button ⑮

Reset security guard password or management office password.

When forgot password, press reset button which is on back side of products 15



(Press & Hold over 3 sec. after power on)

PDF Compressor Free Version

* Call security

1. Press, name search button and call security which is top of the name list.
2. Press "9999" and press call button.

* Must know before use.

- 1) If you hear "beep beep beep..."during any program modes, please restart from the beginning. The beep sounds for improper process.
- 2) If password is forgotten,
 - 2-1) Password for any household :
Use the identifying household password function (6-1) to confirm the password (methods to confirm password shall be requested to the Management office or Security cPress).
 - 2-2) Password for any building:
Reset the password by using Management password
 - 2-3) Password for Management
Press "Reset Button"..
The password will be reset to factory default.
- 3) Deleting All RF Card Keys function in "8-5" shall ONLY be used when the product is initially installed.



4. Password type

4-1. Password for the Management Office ("Management Password")

A password for the Manager

Factory default for the Manager Password is 4321.

4-2. Password for any buildings ("Building Password")

A common password for a corresponding building.

Factory default for the Building Password is 1234.

4-3. Password for any household units "Unit Password")

A password for each household unit can be set.

Factory default for the Unit Password is 1234.

<Reference>

*"P": Program Button * "K": Electronic Key Button * "E": Call Button



* Previous Password

Default password for Management Password is	4321
Building Password is	1234
Unit Password is	1234

* New Password

The password newly set.



5. How to input Password

5-1. Press management Password

- P - old Password - E - New Password - E
- Password must be 4 digits.
- "0000", "1234", "4321" can't be used as Password

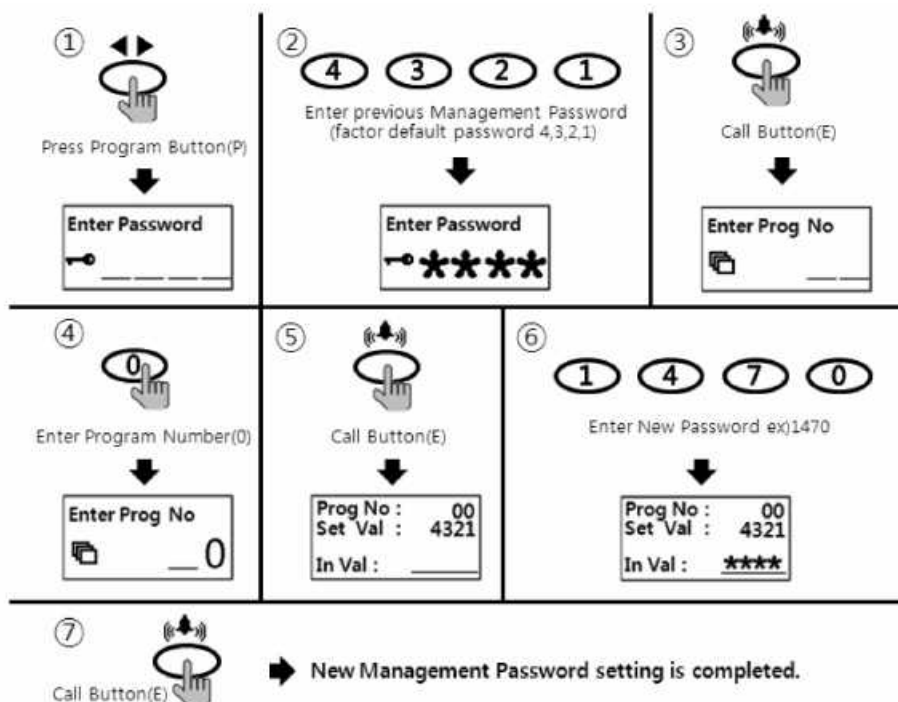

- ① Press program button (P).
- ② Press old management default Password (4,3,2,1).
- ③ Press call button (E).
- ④ Press "0" (Set up management Password button)
- ⑤ Press call button (E).
- ⑥ Press new Password.
- ⑦ Press call button (E).
- ⑧ Management Password has been changed.

<Caution>

Please do not keep the factory default password. New password setting after the installation is strongly recommended.

5-2. Press building Password

- P - old Password - E - 1 - E - New Password - E
- Password must be 4 digits.
- "0000", "1234", "4321" can't be used as Password

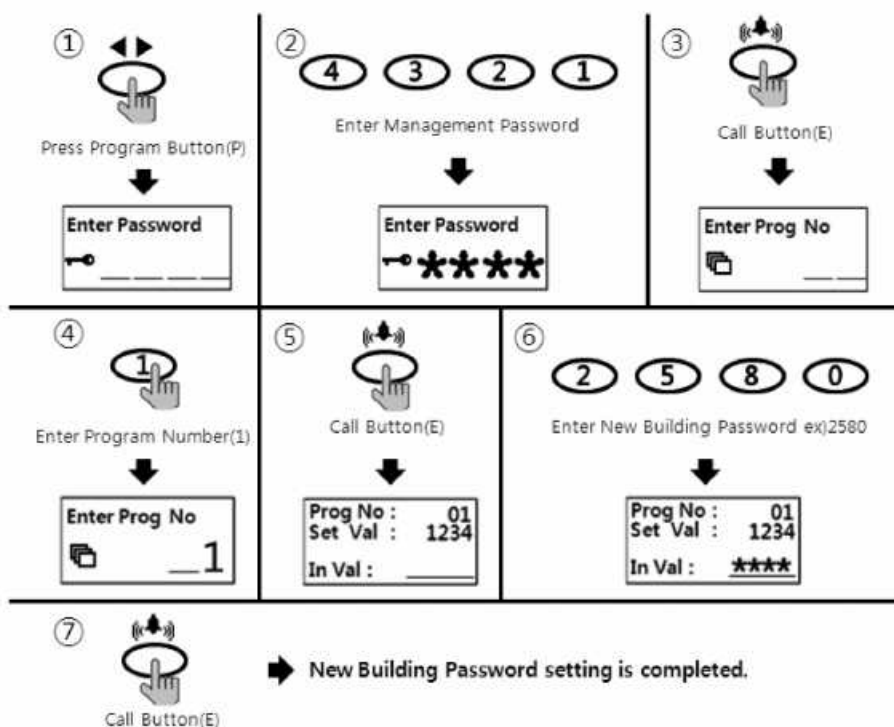

- ① Press program button (P).
- ② Press old building default Password (4,3,2,1).
- ③ Press call button (E).
- ④ Press "1" (Set up building Password button)
- ⑤ Press call button (E).
- ⑥ Press new Password.
- ⑦ Press call button (E).
- ⑧ Building Password has been changed.

5-3. Press house (Unit) Password

- K - 20 - E - house Number - E - old Password - E - New Password - E
- Password must be 4 digits.
- "0000", "1234", "4321" can't be used as Password
- Unit Password no. may not be changed because of Interphone types.

(Some model of Interphone can change Password in house. Please, check manual of interphone)

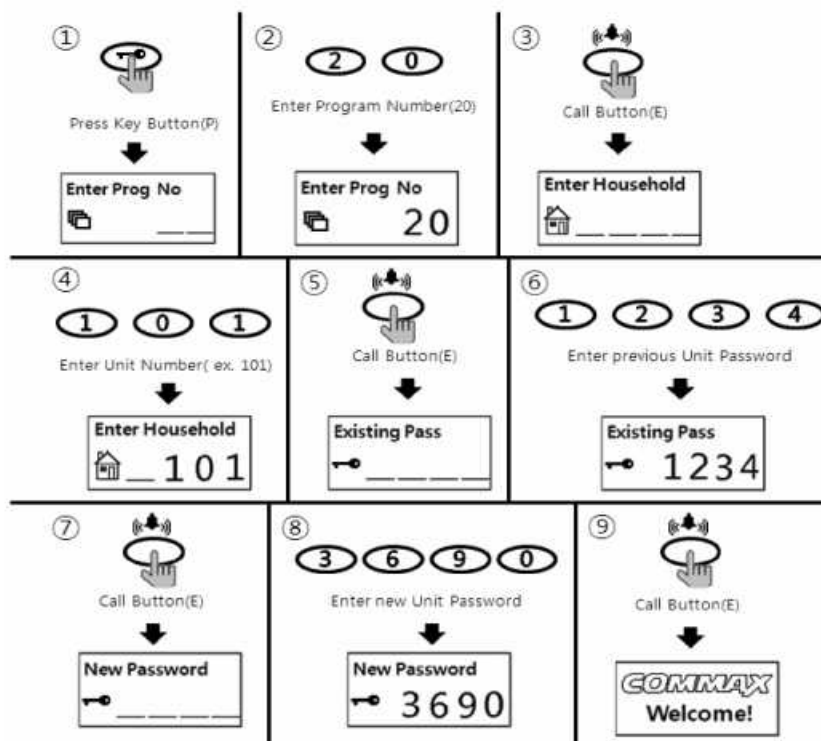

- ① Press program button (K)
- ② Press "20" (Set unit Password Number)
- ③ Press call button (E).
- ④ Press house Number
- ⑤ Press call button (E).
- ⑥ Press old house Password (4,3,2,1).
- ⑦ Press call button (E).
- ⑧ Press new house Password.
- ⑨ Press call button (E).
- ⑩ House Password has been changed.



6. Check house Password

6-1. Check house Password

- P - management Password - E - 16 - E - Household Unit Number E

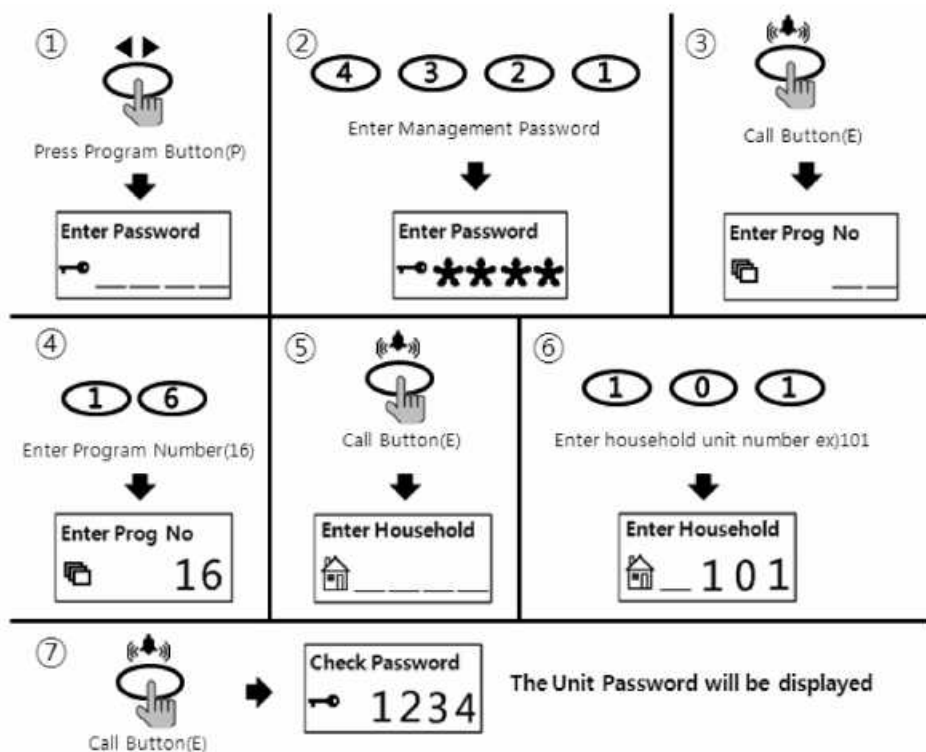

- ① Press program button (P).
- ② Press management Password.
- ③ Press call button (E).
- ④ Press "16" (Set ID Number function key)
- ⑤ Press call button (E).
- ⑥ Press new ID Number
- ⑦ Press call button (E).
- ⑧ ID Number has been changed.



7. Set building Number and ID to Lobby panel

- This setting is mandatory because building Number and ID automatically are set up when lobby panel call house and security guard.
- Max. 99 lobby panel can be installed for one building.

7-1. Set building Number in Lobby panel interphone.

- P - Management Password - E - 2 - E - Building Number - E

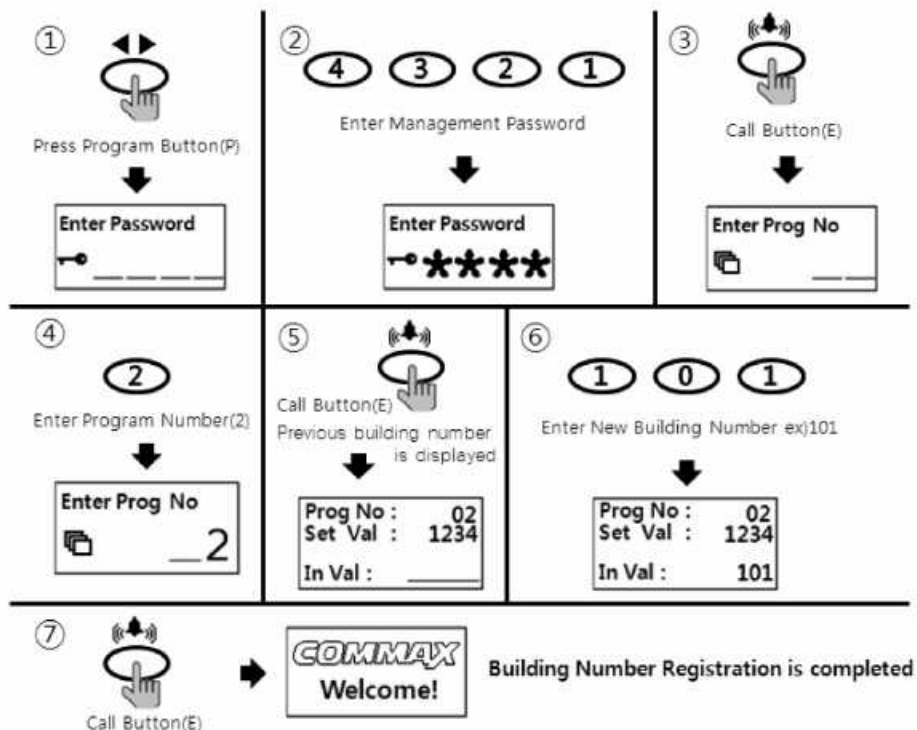

- ① Press program button (P).
- ② Press management Password.
- ③ Press call button (E).
- ④ Press "2" (Set building Number function key)
- ⑤ Press call button (E).
- ⑥ Press new building Number
- ⑦ Press call button (E).
- ⑧ Building Number has been changed.

PDF Compressor Free Version

7-2. Set ID no. in Lobby Panel

- P - Management Password - E - 3 - E - ID - E

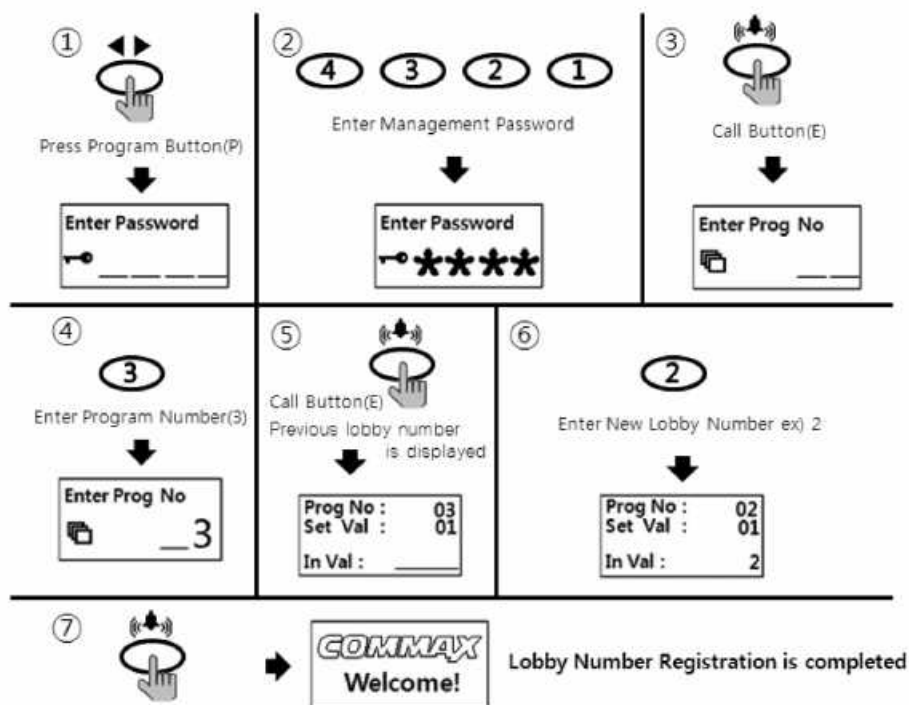

- ① Press program button (P).
- ② Press management Password.
- ③ Press call button (E).
- ④ Press "3" (Set ID Number function key)
- ⑤ Press call button (E).
- ⑥ Press new ID Number
- ⑦ Press call button (E).
- ⑧ ID Number has been changed.



8. RF card key appliances

8-1 RF card key test way

- P- Management Password - E - 9 - E - Card Test - X(Cancel)
- This function is only for the test of wireless card key

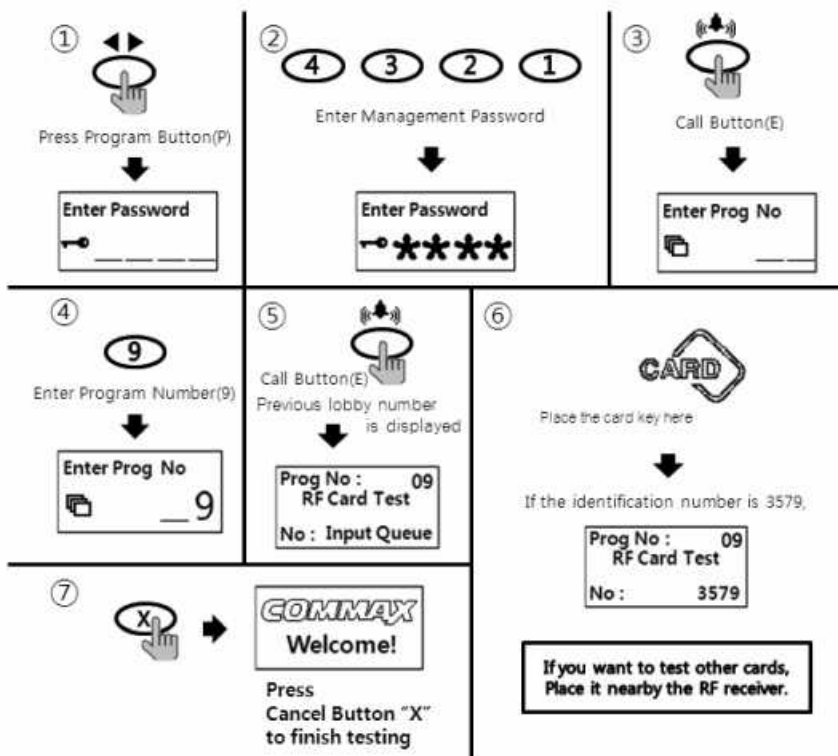

- ① Press down the (P) button
- ② Press Management Passwords
- ③ Press Call Button "E".
- ④ Press number "9" for the test of wireless card key
- ⑤ Press Call Button "E"
- ⑥ The card registration number will be on OLED when the card key is close to the RF/ID receiver.
- ⑦ Press down the (X) button for finish after test.

8-2. RF card key input way

- P- Management Password - E- 10 - E - Place card close to the RF/ID receiver - X(cancel)

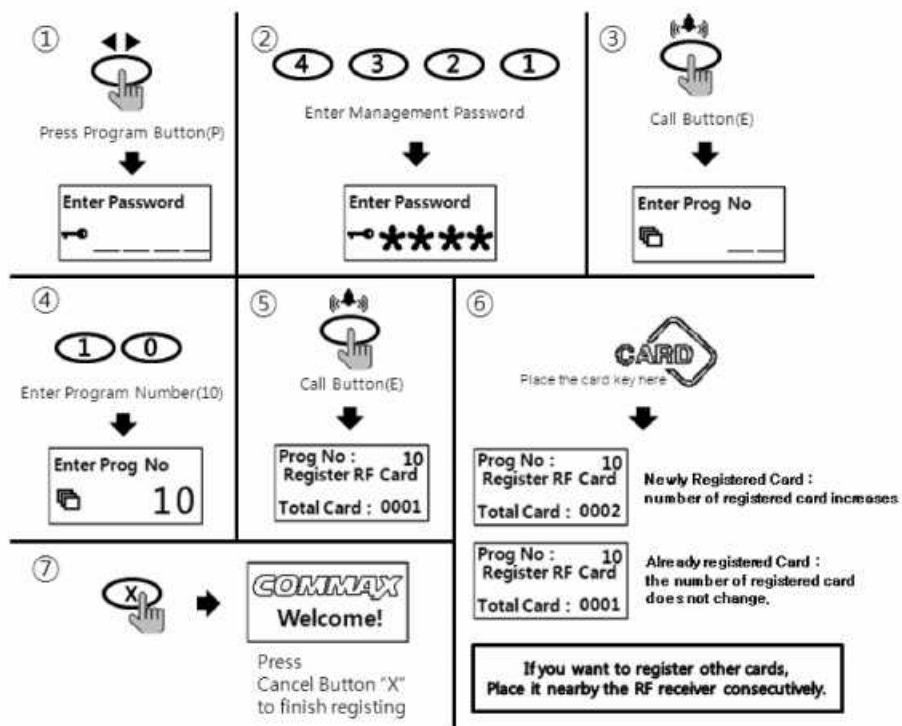

<References>

Up to 2048 cards can be registered(if not to connect with SecuMAX)

8-3. RF card key separate deletion way

- P - Management Password - E - 12 - E - Delete cards - X(Cancel)

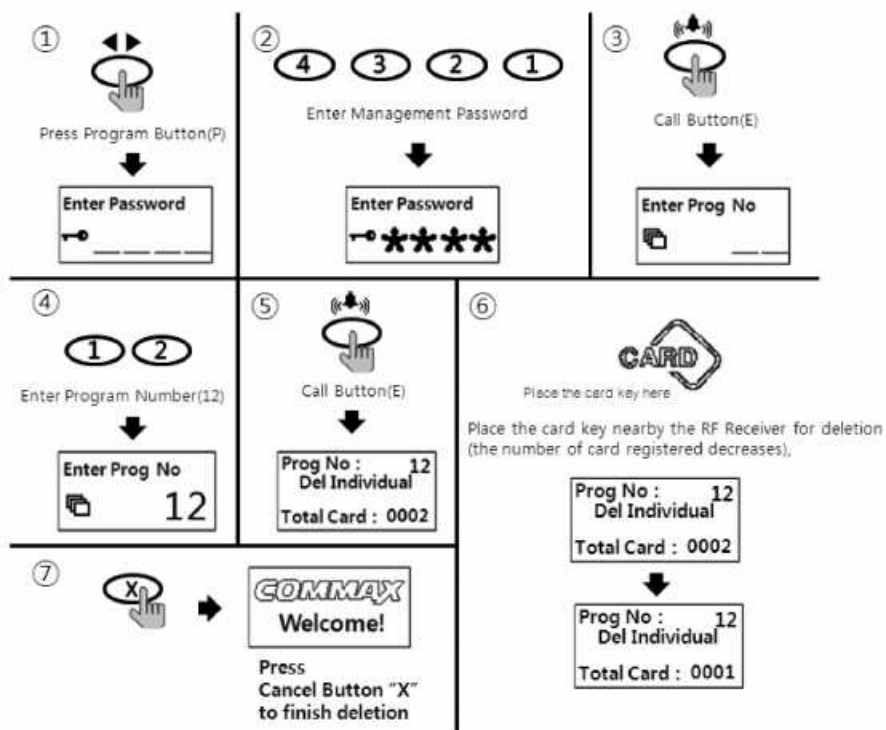

- ① Press Program Button "P"
- ② Press Management Password
- ③ Press Call Button "E"
- ④ Press number "12"(separate delete number)
- ⑤ Press Call Button "E"
- ⑥ Place the card key close to the RF/ID receiver.
- ⑦ Press down the "X" to finish when separate deletion is completed

8-4. RF card key registration check way

- P- Management password - E - 13 - E - Check the cards - X(Cancel)

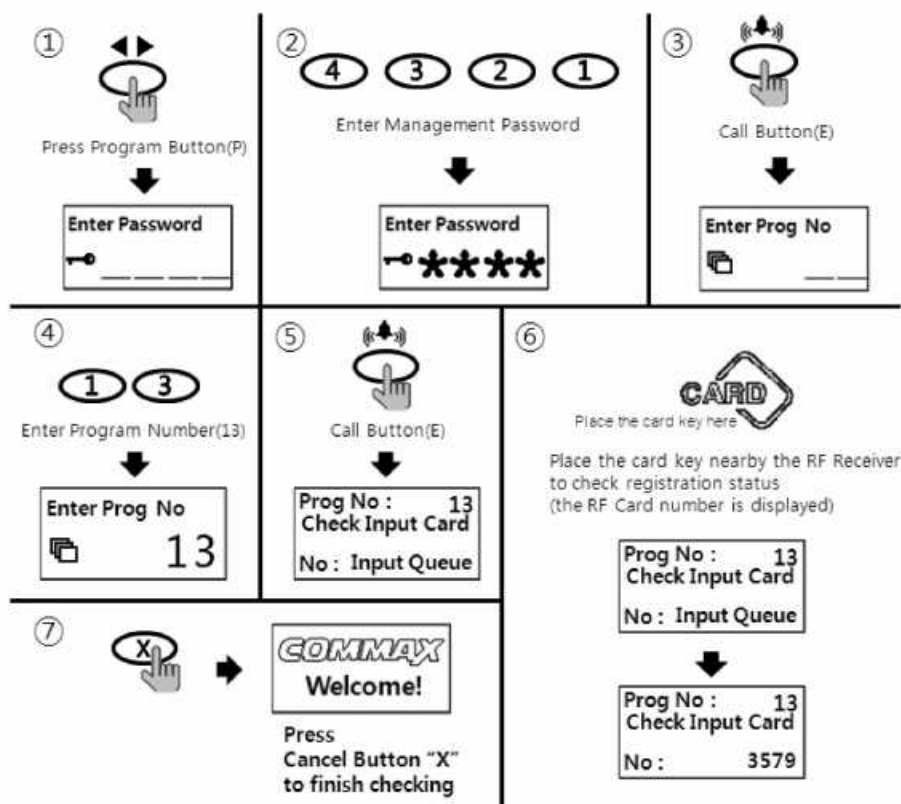

- ① Press Program Button "P"
- ② Press Management Password
- ③ Press Call Button "E"
- ④ Press number "13"(registration check)
- ⑤ Press Call Button "E"
- ⑥ Place the card key close to the RF/ID receiver
- ⑦ Press down X button to finish when check is completed

8-5. RF card key all delete way

- P - Management password - E - 11 - E - E
- All deletion way is only useful when initially set up, unless all registered cards are to be deleted.

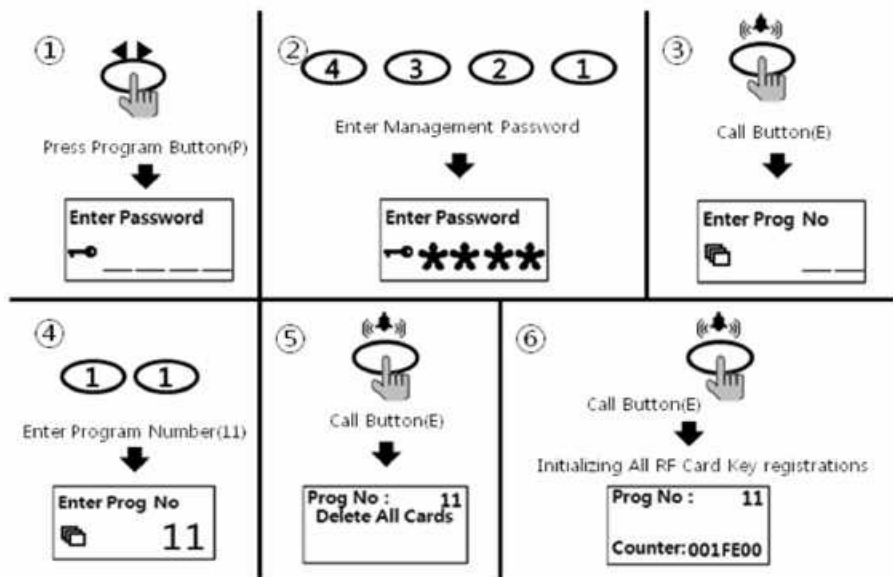

- ① Press down "P" button
- ② Press Management Password
- ③ Press down "E" button
- ④ Press number "11" (all delete number)
- ⑤ Press Call Button "E"
- ⑥ Press Call Button "E" one more
- ⑦ The number on OLED display to be changed
- ⑧ Press down X button if to cancel.

<References>

All numbers can be deleted only if the mode "1" in the program number(23) is selected & executed the all delete process within 30 seconds.

8-6. RF card key capacity change way

- P- Management password - E - 19 - E - 0 - E : Up to 2048 RF Cards can be registered
- P- Management password - E - 19 - E - 1 - E : Unlimited RF Cards can be registered

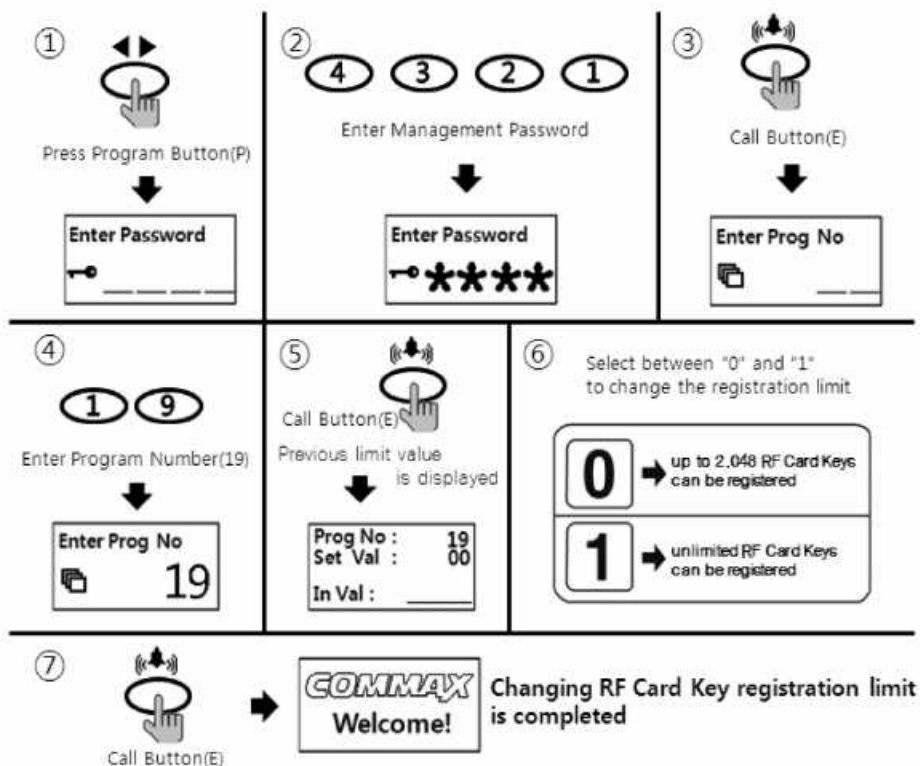

- ① Press down "P" button
- ② Press Management Password
- ③ Press down "E" button
- ④ Press number "19" (capacity change number)
- ⑤ Press Call Button "E"
- ⑥ Select mode between numbers "0" and "1".
(0 : Up to 2048 RF Card Keys can be registered)
(1 : Unlimited RF Card Keys can be registered)
- ⑦ Press Call Button "E"

8-7. RF card key data transmission

- P - Management Passwords - E - 32 - E - Press destination lobby phone number - E

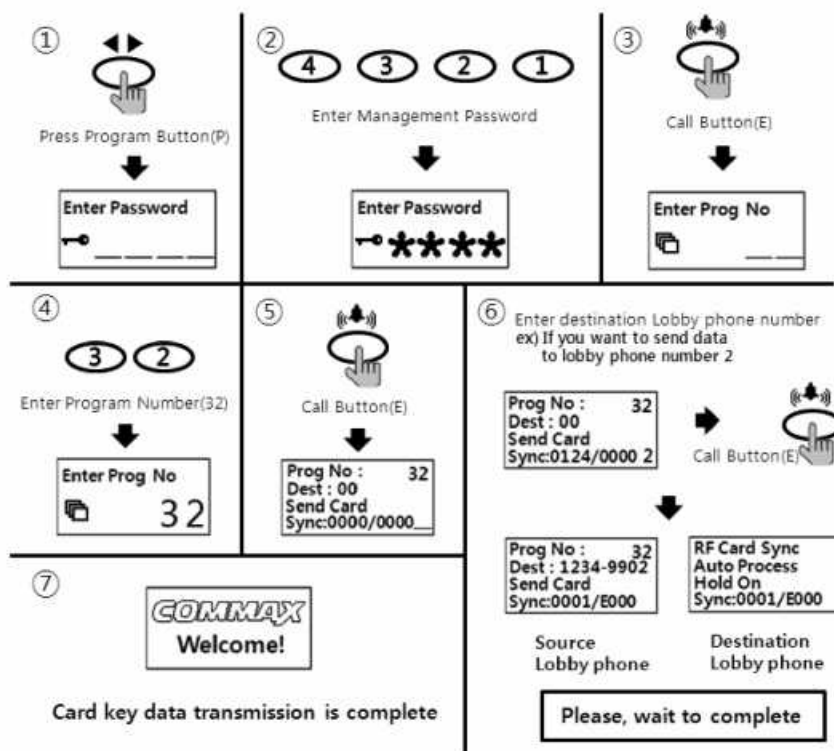

- ① Press Program Button "P"
- ② Press Management password
- ③ Press Call Button "E"
- ④ Press number "32" for data transmission
- ⑤ Press Call Button "E"
- ⑥ Press number "destination lobby phone number"
- ⑦ Press Call Button "E"

<References>

- Data can be sent only if the mode "99" in the program number(23) is selected & executed the process within 30 seconds.
- You cannot use any other function before it completes(It takes about 5 minutes). If you want to complete more quickly, use the download program.

8-8. RF card key data reception

- P- Management Passwords - E - 33 - E - Press source lobby phone number - E

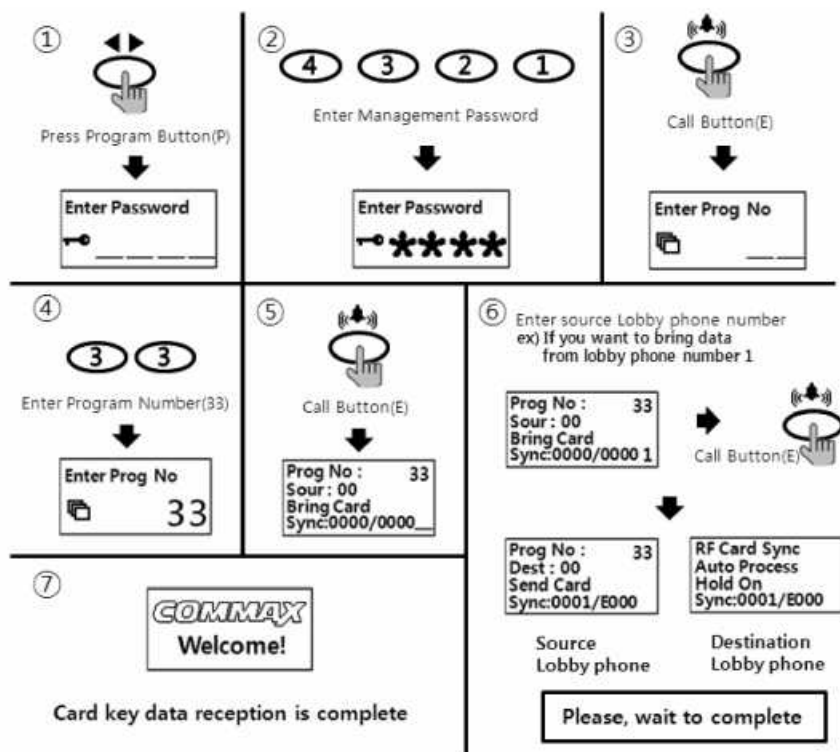

- ① Press Program Button "P"
- ② Press Management password
- ③ Press Call Button "E"
- ④ Press number "33" for data reception
- ⑤ Press Call Button "E"
- ⑥ Press number "source lobby phone number"
- ⑦ Press Call Button "E"

<References>

- Data can be received only if the mode "99" in the program number(23) is selected & executed the process within 30 seconds.
- You cannot use any other function before it completes(It takes about 5 minutes). If you want to complete more quickly, use the download program.



9. Door release by internal information forwarding to SecuMAX way

- P - Management password - E - 22 - E - 0 - E : Forwarding to SecuMAX disabled
- P - Management password - E - 22 - E - 1 - E : Forwarding to SecuMAX enabled
- This function is to set the door release by internal sensor information forwarding to SecuMAX.

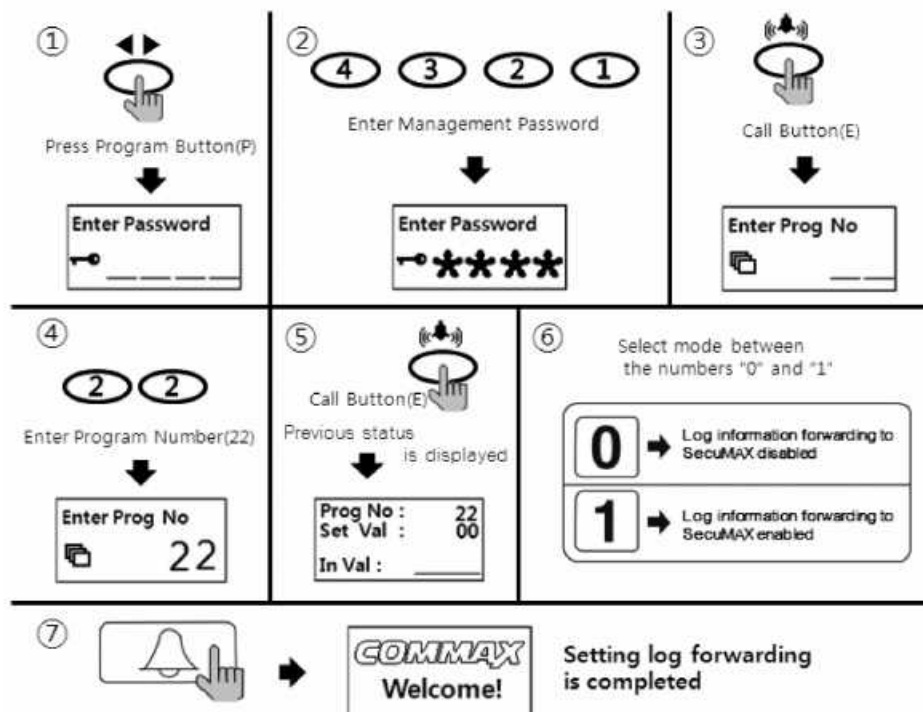

- ① Press Program Button "P"
- ② Press Management Passwords
- ③ Press Call Button "E" for call
- ④ Press number "22" for forwarding to SecuMAX
- ⑤ Press Call Button "E"
- ⑥ Select the mode
(0 : Forwarding to SecuMAX disabled)
(1 : Forwarding to SecuMAX enabled)
- ⑦ Press Call Button "E"



10. Door opening hours setting

- P - Management Passwords - E - 5 - E - Opening hours - E
- This function is to control the common entrance door opening hours

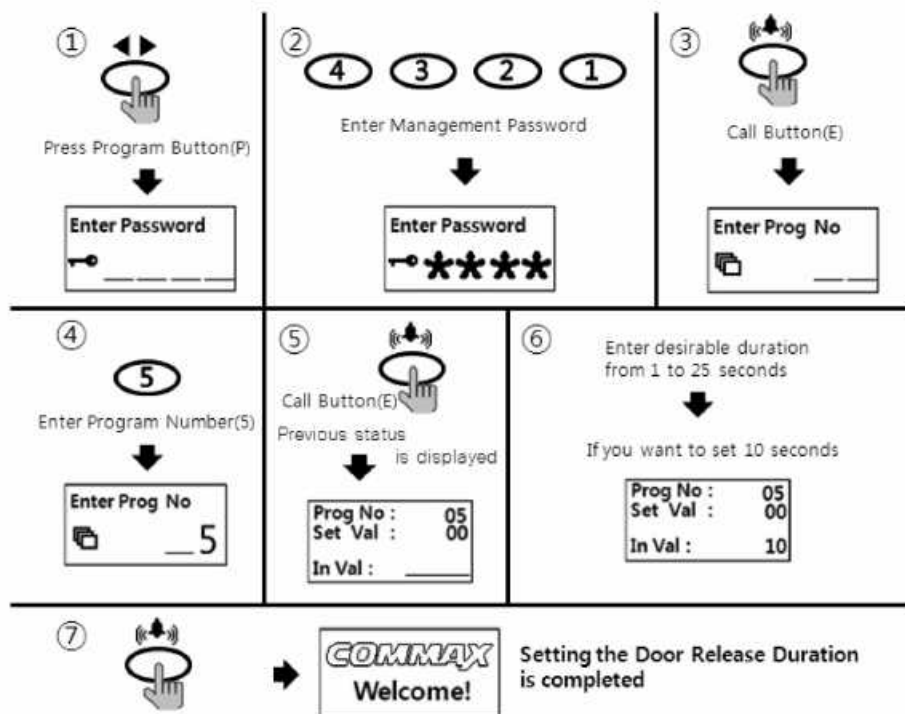

- ① Press Program Button "P"
- ② Press Management Passwords
- ③ Press Call Button "E"
- ④ Press number "5" for door opening hours setting
- ⑤ Press Call Button "E"
- ⑥ Select door opening hours(Opening hours is in the middle of 1~25 seconds)
- ⑦ Press down any number for setting of door opening hours between 0~25 seconds
- ⑧ Press Call Button "E"(Changed opening hours is input)



11. Line-by-line call function Setting

- P - Management password - E - 21 - E - 0 - E : available for entire house call
- P - Management password - E - 21 - E - Line number - E : call only specified line
ex) In case 1 line ~ 2 line, input "0102"
- This function is only for specified line call, not for entire house call

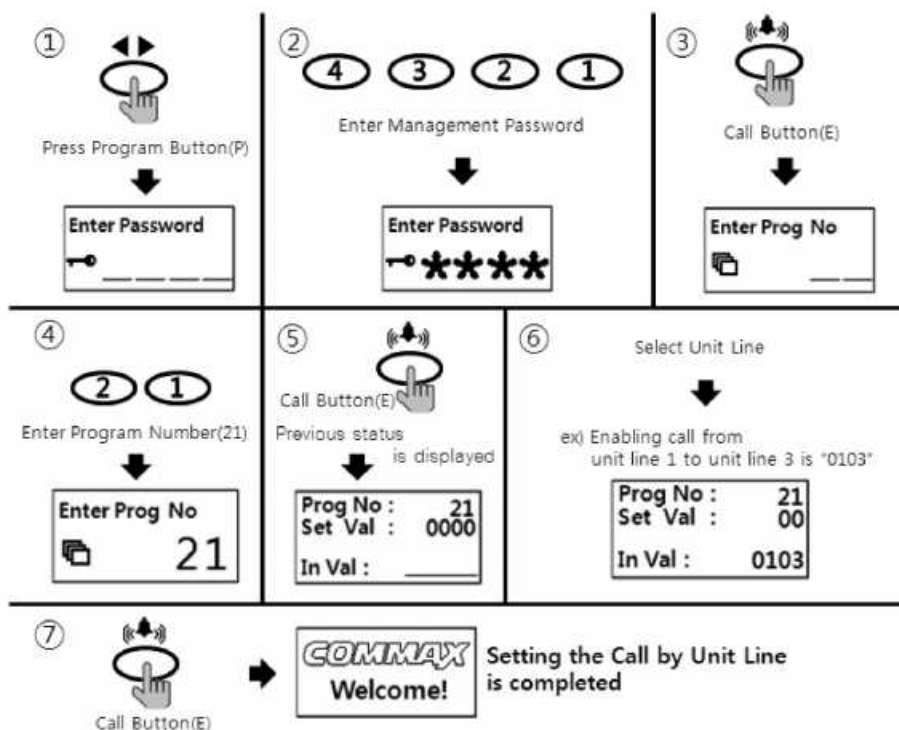

- ① Press Program Button "P"
- ② Press Management Passwords
- ③ Press Call Button "E"
- ④ Press number "21" for call line-by-line
- ⑤ Press Call Button "E"
- ⑥ Select the line for call
ex) If to call only from 1 line to 3 line, Press "0103"
- ⑦ Press Call Button "E"(Changed setting would be input)



12. Automatic calling function of guard station configuration

- P - Management password - E - 27 - E - 0 - E : Automatic call mode
- P - Management password - E - 27 - E - 1 - E : Emergency call mode
- This function is to set the automatic calling to the security station when the failure of Password occurs more than 3 times.

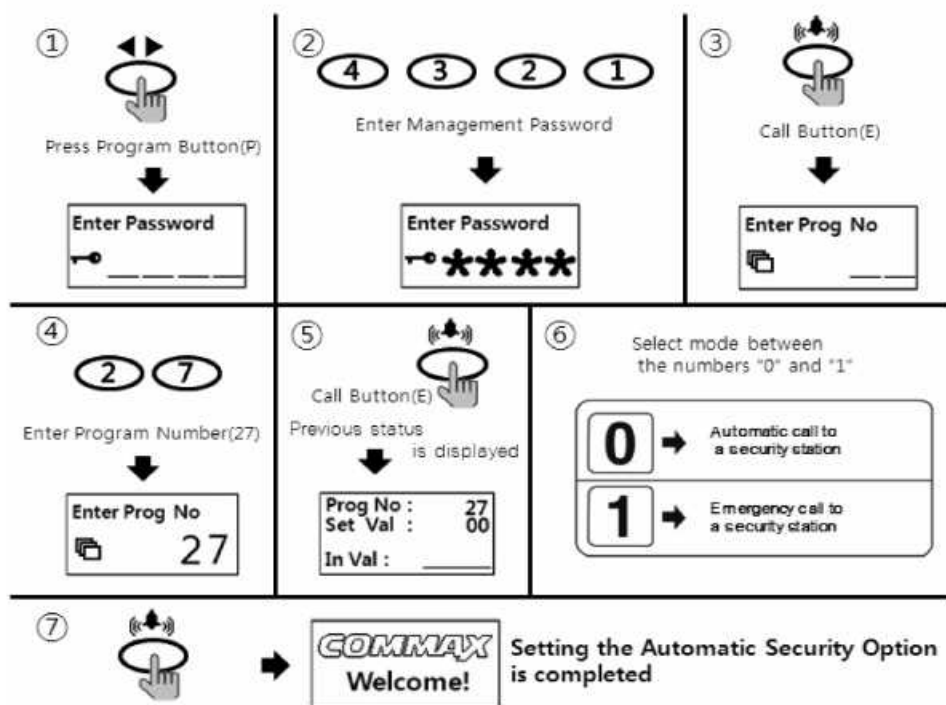

- ① Press Program Button "P"
- ② Press Management Passwords
- ③ Press Call Button "E" for call
- ④ Press number "27"
- ⑤ Press Call Button "E"
- ⑥ Select the mode
(0 : Automatic call mode)
(1 : Emergency call mode)
- ⑦ Press Call Button "E"



13. Call Tones selection

- P - Management password - E - 7 - E - 0 - E : Melody sound
- P - Management password - E - 7 - E - 1 - E : Bell(Ringer sound)
- This function is to set the recall sound of house & guard station at the common entrance

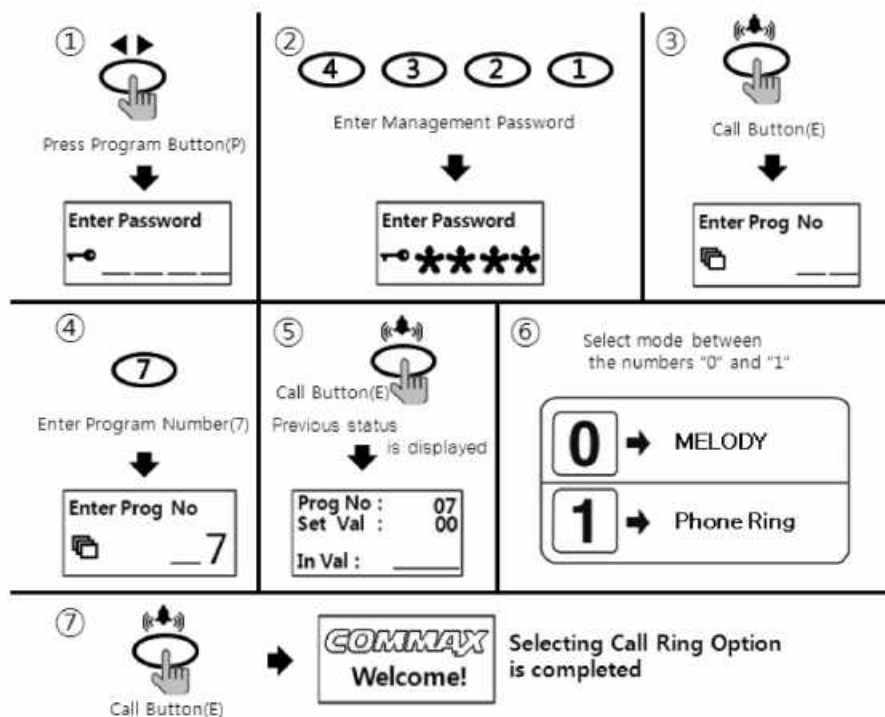

- ① Press Program Button "P"
- ② Press Management Passwords
- ③ Press Call Button "E" for call
- ④ Press number "7" for selection of call tones
- ⑤ Press Call Button "E" for cal
- ⑥ Select the mode
(0 : Melody sound)
(1 : Bell sound)
- ⑦ Press Call Button "E"(Changed call tones will be set)



14. Setting the Number of Call Ring Repetitions

- P - Management Password - E - 25 - E - 0 - E : Continuous call ring enabled.
- P - Management Password - E - 25 - E - 1 - E : 1 time Call ring enabled.
- This function sets number of call ring repetition when a call is made to any households or security office.

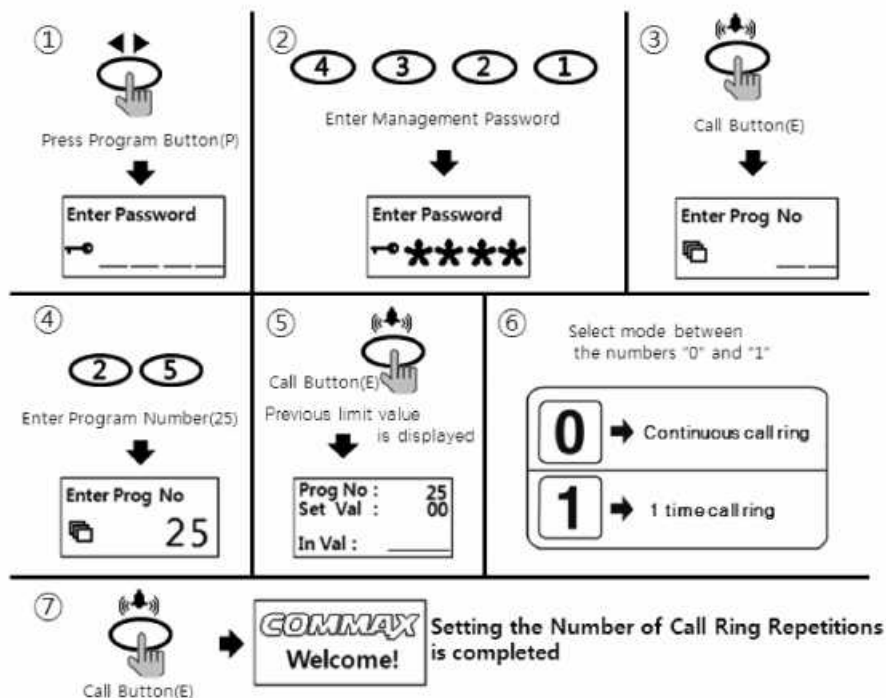

- ① Press Program Button "P".
- ② Press Management Password.
- ③ Press Call Button "E".
- ④ Press "25" (number twenty-five)
- ⑤ Press Call Button "E".
- ⑥ Select the mode
(0 : Continuous call ring)
(1 : 1 time call ring)
- ⑦ Press Call Button "E"



15. Door release by external information forwarding to SecuMAX way

- P - Management password - E - 18 - E - 0 - E : Forwarding to SecuMAX disabled
- P - Management password - E - 18 - E - 1 - E : Forwarding to SecuMAX enabled
- This function is to set the door release by internal sensor information forwarding to SecuMAX.

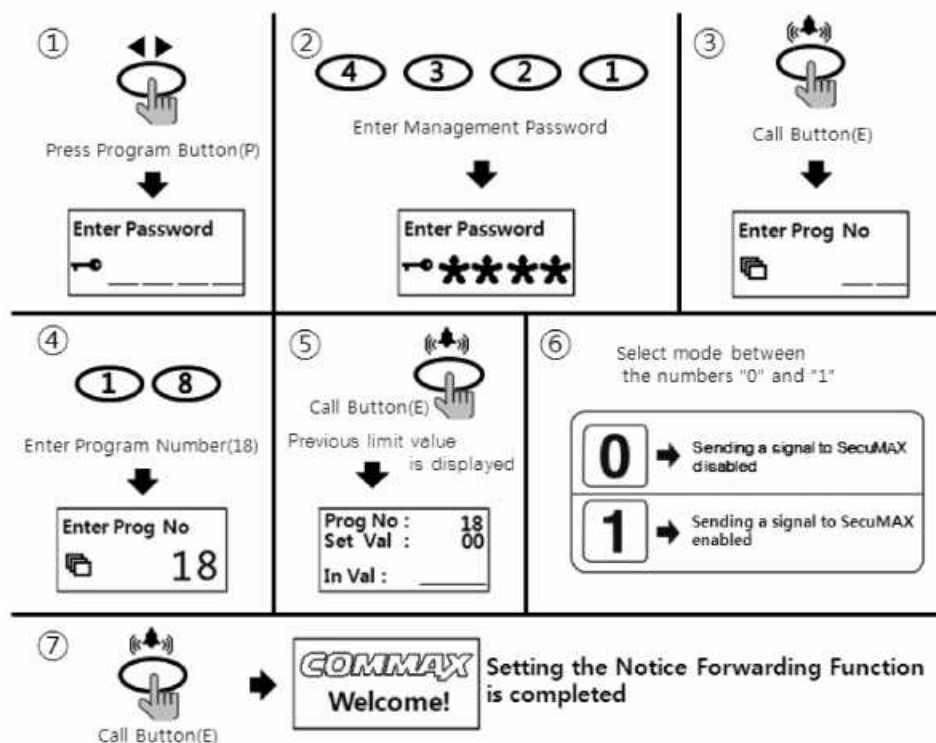

- ① Press Program Button "P"
- ② Press Management Passwords
- ③ Press Call Button "E" for call
- ④ Press number "18" for forwarding to SecuMAX
- ⑤ Press Call Button "E"
- ⑥ Select the mode
(0 : Forwarding to SecuMAX disabled)
(1 : Forwarding to SecuMAX enabled)
- ⑦ Press Call Button "E"



16. Set to be forced opening the Main Entrance door by SecuMAX

- P - Management password - E - 29 - E - 0 - E : Forced opening by SecuMAX disabled
- P - Management password - E - 29 - E - 1 - E : Forced opening by SecuMAX disabled
- This function is to set the opening the Main Entrance door forced opening by SecuMAX

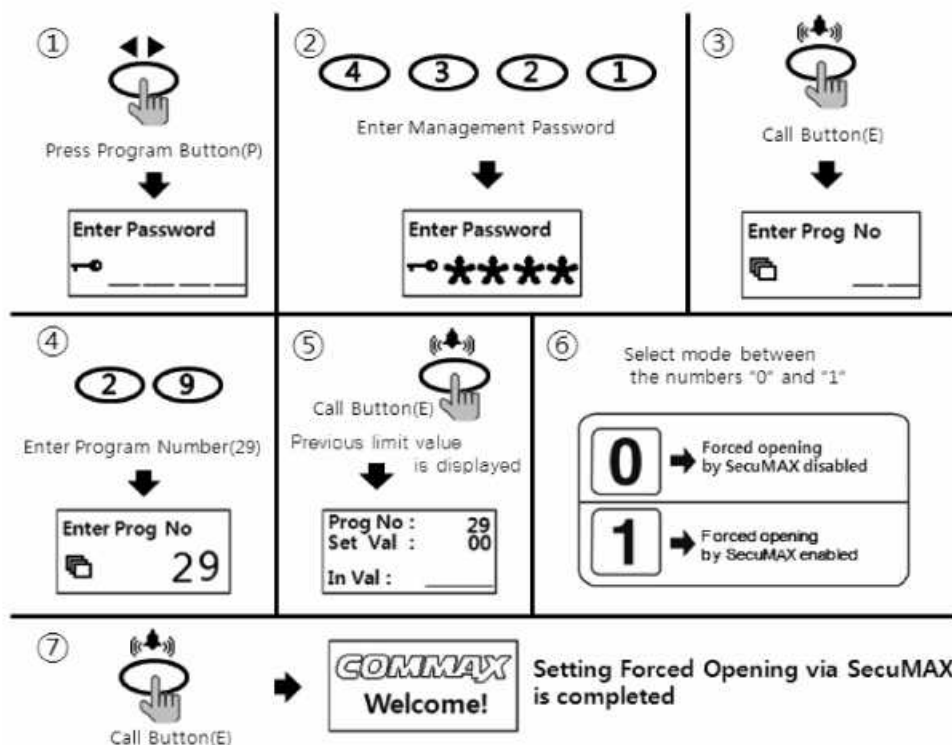

- ① Press Program Button "P"
- ② Press Management Passwords
- ③ Press Call Button "E" for call
- ④ Press number "29"
- ⑤ Press Call Button "E"
- ⑥ Select the mode
(0 : Forced opening by SecuMAX disabled)
(1 : Forced opening by SecuMAX enabled)
- ⑦ Press Call Button "E"



17. Setting the time to trigger the notice to be forced door forwarding to SecuMAX

- P - Management password - E - 24 - E - 0 - E : This function is disabled
- P - Management password - E - 29 - E - 1 - E : Set the time(second)
- This function is to set the time to trigger the notice to be forced door forwarding to SecuMAX
- If you use this function, you should set the time more 1 second than the door close time.
- The notice forwarding to SecuMAX after 2 seconds when to be forced opening

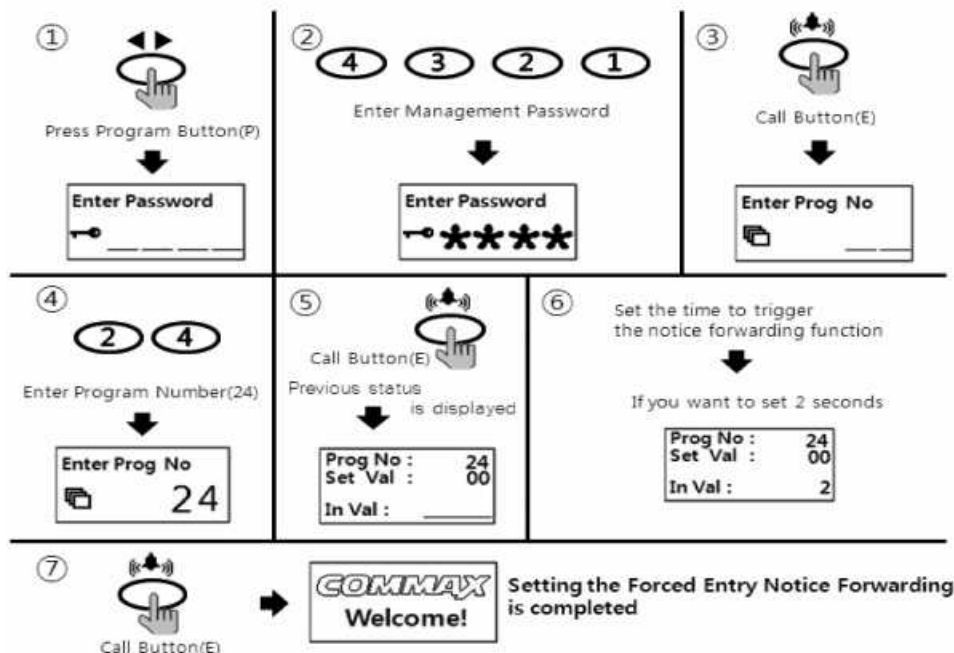

- ① Press Program Button "P"
- ② Press Management Passwords
- ③ Press Call Button "E" for call
- ④ Press number "24"
- ⑤ Press Call Button "E"
- ⑥ Select the mode
(0 : This function is disabled)
(1 : Set the time(1~25 seconds))
- ⑦ Press Call Button "E"



18. Selecting the Wiring Method

- P - Management Password - E - 6 - E - 4 - E : common 4 wire method
- P - Management Password - E - 6 - E - 6 - E : common 6 wire method
- If common 6 wire method selected, there will be no video signal sent to all household units.

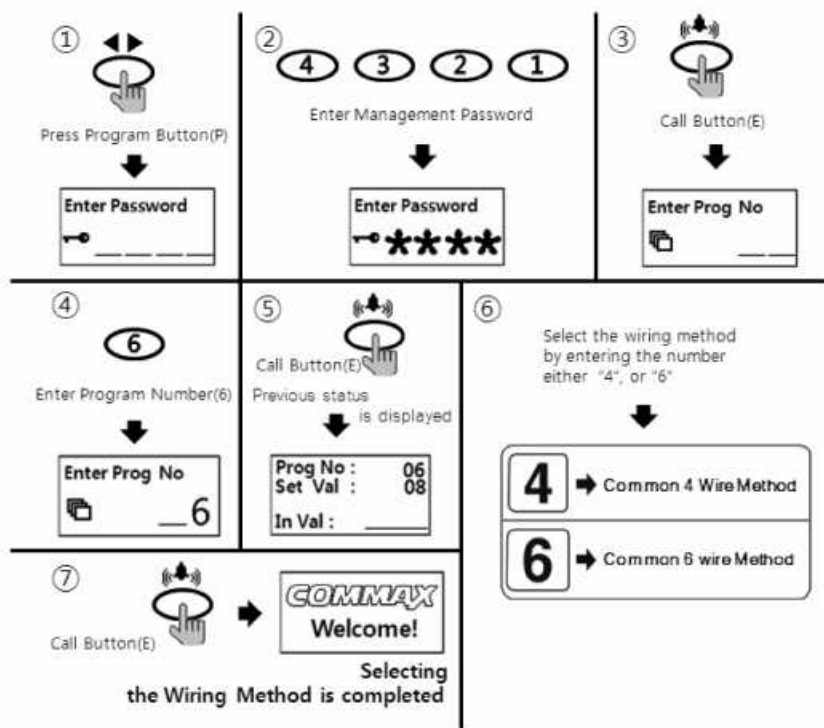

- ① Press Program Button "P".
- ② Press Management Password.
- ③ Press Call Button "E".
- ④ Press "6" (number six).
- ⑤ Press Call Button "E".
- ⑥ Select the wiring method by Pressing number
(4 : Common 4 Wire Method)
(6 : Common 6 Wire Method)
- ⑦ Press Call Button "E".



19. Video Out Impedance Adjustment Setting

- P - Management Password - E - 8 - E - 0 - E : Short distance transmission.
- P - Management Password - E - 8 - E - 1 - E : Long distance transmission.
- Factory default is set as "short distance transmission".

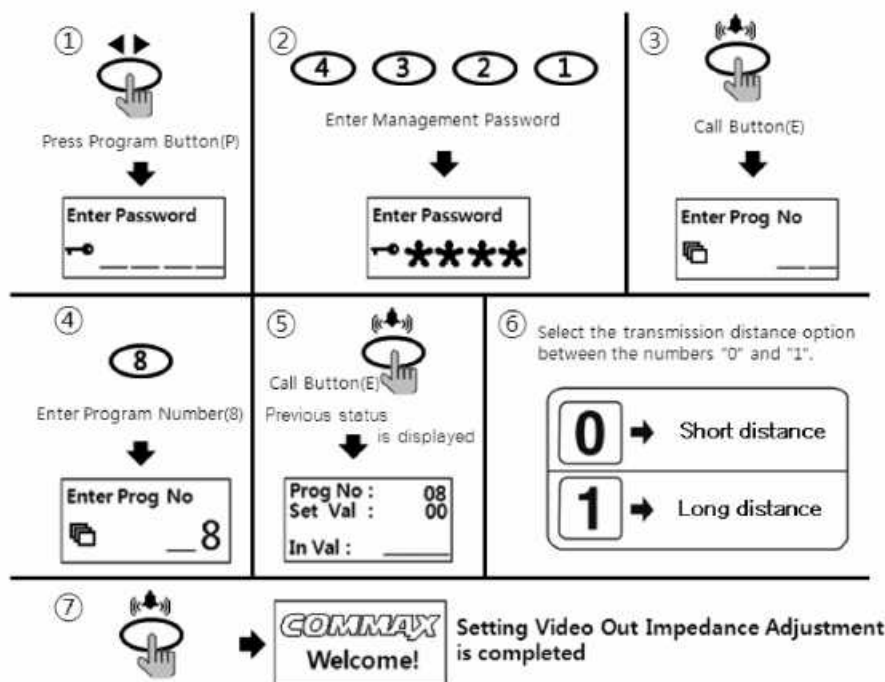

- ① Press Program Button "P".
- ② Press Management Password.
- ③ Press Call Button "E".
- ④ Press "8" (number eight).
- ⑤ Press Call Button "E".
- ⑥ Select the transmission distance option between numbers "0" and "1".
(0 : Short distance)
(1 : Long distance)
- ⑦ Press Call Button "E".



20. Registration of Household Unit Number

- P - Management Password - E - 15 - E - Call Security from the monitor.- number of household - E - serial number - E
- This method applies to the case that there is no security station installed. Calling security from the monitor will direct the call to the lobby phone. Household Unit Number can be set at the lobby phone.

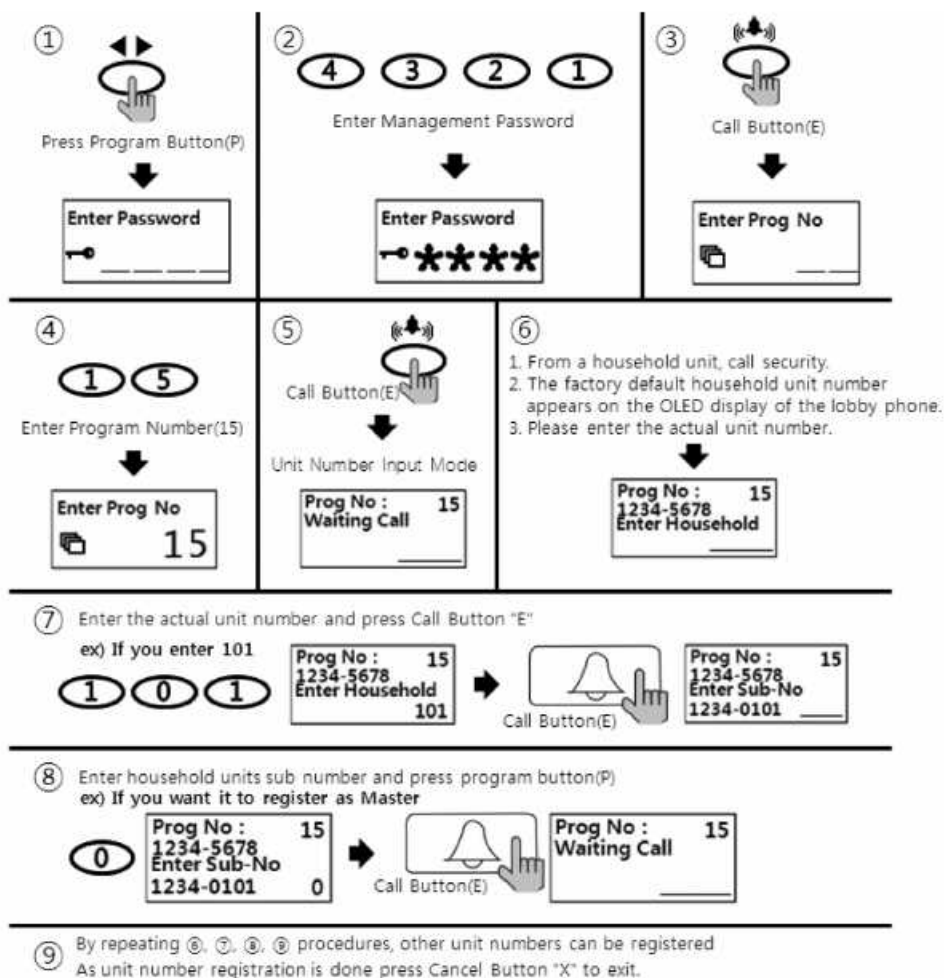

- ① Press Program Button "P".
- ② Press Management password.
- ③ Press Call Button "E".
- ④ Press "15" (number fifteen).
- ⑤ Press Call Button "E".
- ⑥ From a household unit, call security. The factory default household unit number appears on the OLED display of the lobby phone. Please Press the actual unit number.
- ⑦ Press the actual unit number and press Call Button "E".
- ⑧ Press "0" (0 is Master lobby phone number. If multiple lobby phones are installed, please Press the corresponding lobby phone number) and press Call Button "E".
- ⑨ On the OLED display, the unit number input mode appears.
- ⑩ By repeating 6, 7, 8, 9 procedures, other unit numbers can be registered.
- ⑪ As unit number registration is done press Cancel Button "X" to exit.

<References>

- Master-videophone's "Multi Sub Number" is number 0 (zero).
- Sub-videophone's "Multi Sub Number" is given between 1 and 3.
- Up to 4 videophones can be installed in a single household unit and the "Multi Sub Numbers" shall not be overlapped.
- "Multi Sub Numbers" for sub-videophones shall be registered in numerical order.
- At least one Master-videophone with "Multi Sub Number 0" must be installed and if only one videophone is installed, it is considered as Master-videophone (set as Multi Sub Number 0).
- In case that ADT-481 is installed, it does not register as Master unit.
- If sub-videophone is 485 system, its Master-videophone's Multi Sub Number is 1 (one) and those of sub-videophones are between 2 and 9.



21. Checking Videophone Status of Household Units

- P - Management password - E - 14 - Unit Number - E - serial number - E
- This function is to check the status of videophones installed in each household unit.

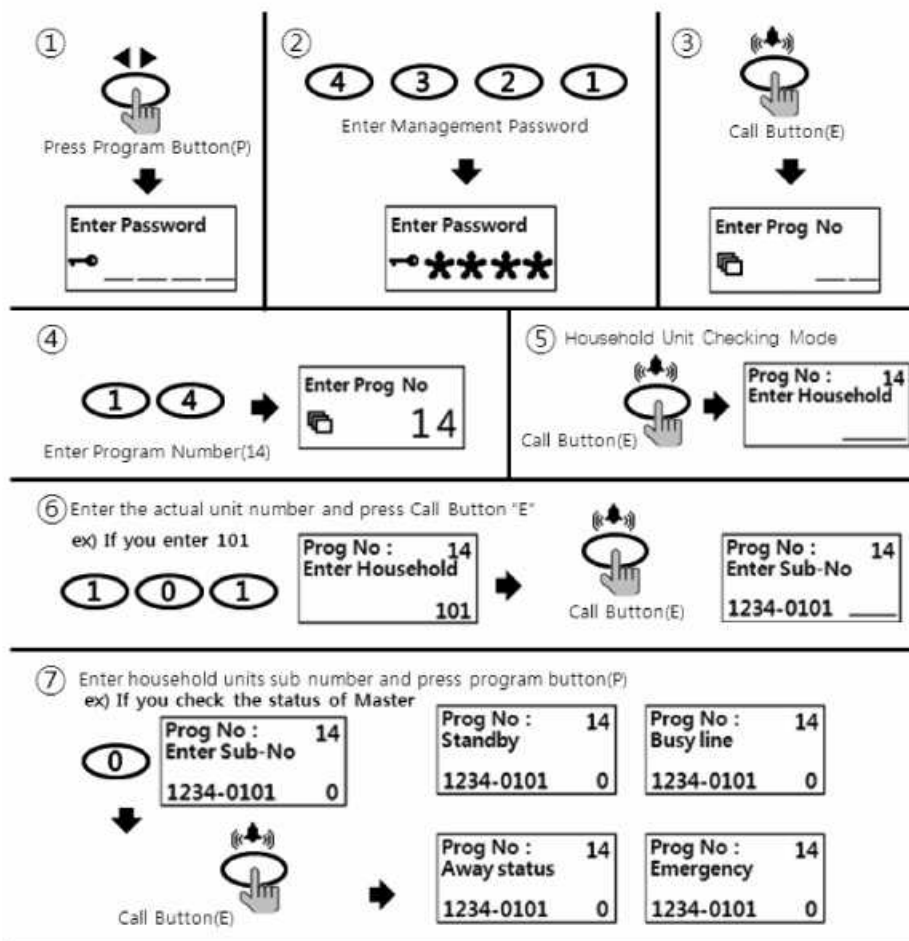

- ⑧ By repeating ⑥, ⑦ procedures, other unit numbers can be registered
As unit number registration is done press Cancel Button "X" to exit.

- ① Press Program Button "P".
- ② Press Management Password.
- ③ Press Call Button "E".
- ④ Press "14" (number fourteen).
- ⑤ Press Call Button "E".
- ⑥ Press the Unit Number and press Call Button "E".
- ⑦ Press "0" (number zero as Master lobby phone or Press a corresponding lobby phone number) and press Call Button "E". Status of the household unit appears (Please refer to below for the status).
- ⑧ To check another unit status, repeat 6 & 7 procedures.
- ⑨ As the status check is done press Cancel Button "X" to exit.

Status of household unit indication

- Standby : standby mode (applies even when the household unit monitor is communicating with an individual door phone of the unit or via telephone line).
- Busy Line : Busy mode (applies when the household unit monitor is communicating with another household unit or security station).
- Away status : Away mode
- Emergency : in case of emergency (emergency, fire, gas leak, burglar)
- Error : Communication failure/error (Please check the unit's videophone).



22. Setting the Keypad LED Option

- P – Management Password – E – 20 – 0 – E : Keypad LED OFF
- P – Management Password – E – 20 – 1 – E : Keypad LED ON
- This function to set keypad LED ON/OFF.

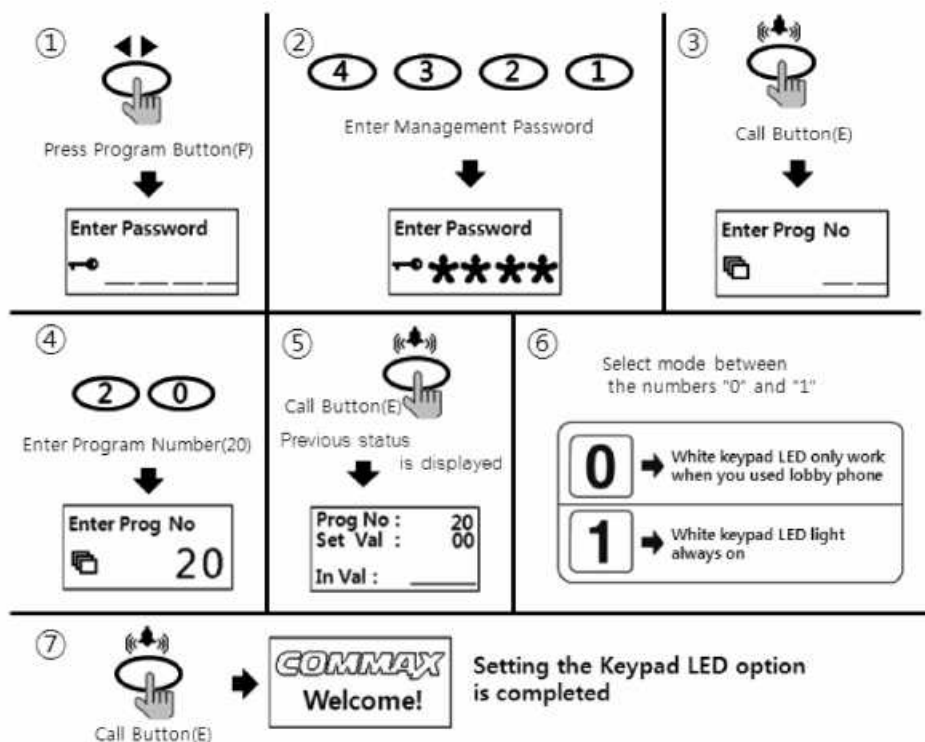

- ① Press the program button (P).
- ② Please set up the Management password.
- ③ Press the call button (E).
- ④ Press number "20" (setting number of Electronic key)
- ⑤ Press the call button (E).
- ⑥ Select mode by numbers "0" or "1".
(0 : White keypad LED light only work when you used lobby phone)
(1 : White keypad LED light always on)
- ⑦ Press the call button (E).(It will be changed)



23. Activation of Electronic Key (Password) Function

- P - Management Password - E - 31 - 1 - E : Electronic Key (Password) enabled.
- P - Management Password - E - 31 - 0 - E : Electronic Key (Password) disabled.
- This function is to enable or disable the password access.

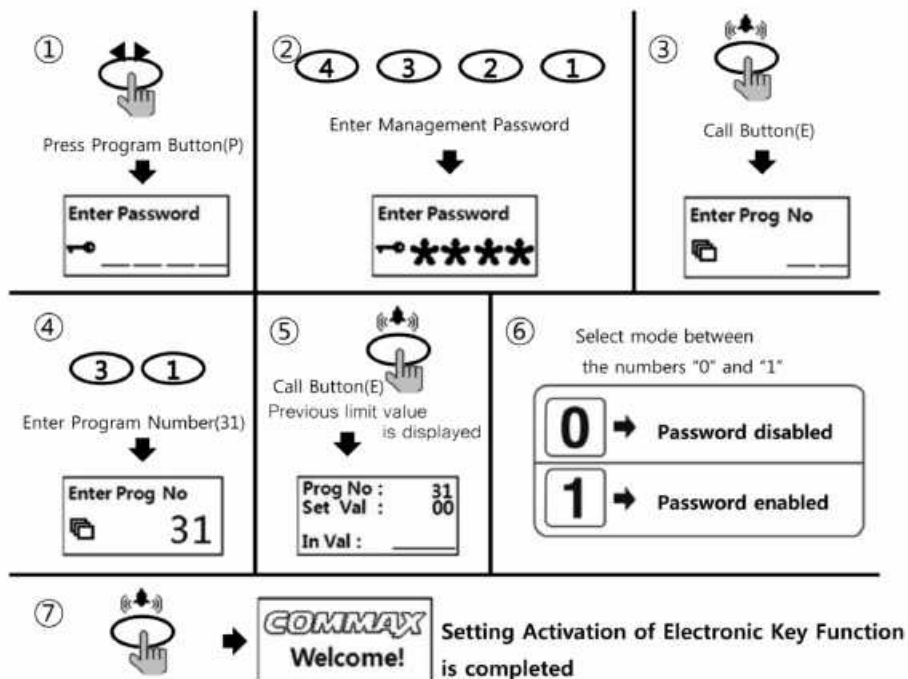

- ① Press Program Button "P".
- ② Press Management Password.
- ③ Press Call Button "E".
- ④ Press "31" (number thirty-one).
- ⑤ Press Call Button "E".
- ⑥ Select mode between numbers "0" and "1".
(1 : Password enabled)
(0 : Password disabled)
- ⑦ Press Call Button "E".



24. Setting the Volume of Voice and Beep Sound

- P - Management Password - E - 30 - E - Beep Volume (1~2) - Voice Volume (1~7) - E
- This function enables the adjustment of Beep & Voice volume.

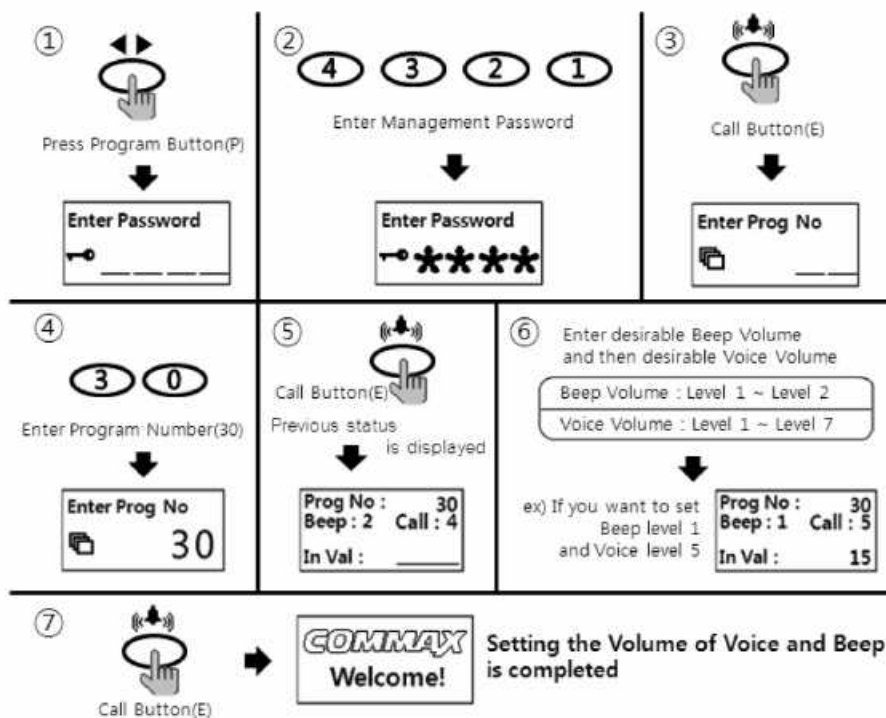

- ① Press Program Button "P".
- ② Press Management Password.
- ③ Press Call Button "E".
- ④ Press "30" (number thirty).
- ⑤ Press Call Button "E".
- ⑥ Press desirable Beep Volume (1~2) and then desirable Voice Volume (1~7).
- ⑦ Press Call Button "E".

<References>

- Beep sound volume applies to paging tone and button sound tone.



25. Method of name data sending

- P - Management Password - E - 34 - E - Press destination lobby phone number - E

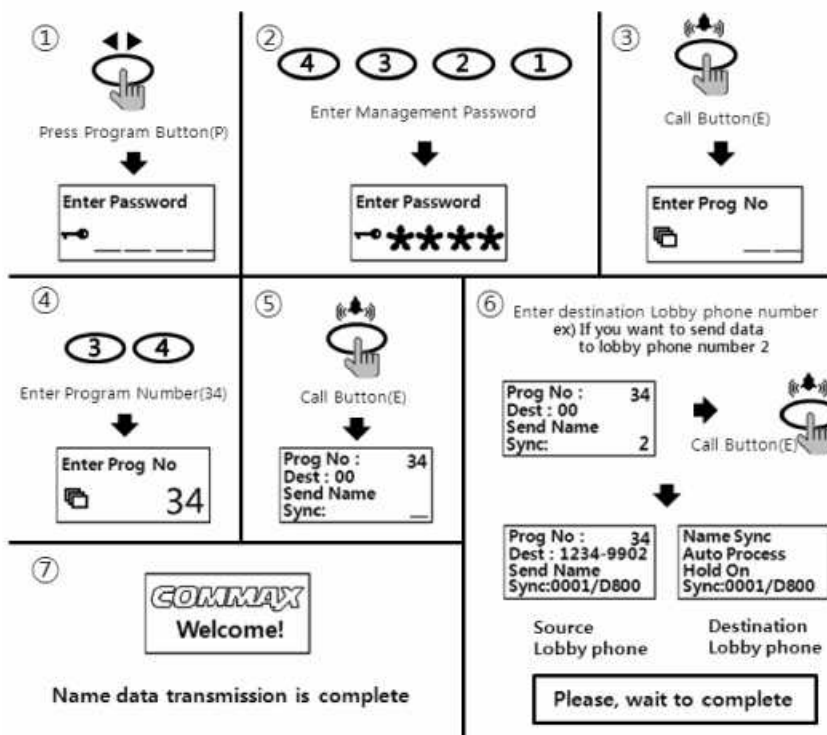

- ① Press Program Button "P".
- ② Press Management Password.
- ③ Press Call Button "E".
- ④ Press number "34" (setting number of caller name)
- ⑤ Press Call Button "E".
- ⑥ Press number "destination lobby phone number"
- ⑦ Press Call Button "E".

<References>

- Data can be send only if the mode "99" in the program number(23) is selected & executed the process within 30 seconds.
- You cannot use any other function before it completes(It takes about 5 minutes). If you want to complete more quickly, use the download program.



26. How to receive the name of the data

- P - Management Password - E - 35 - E - Press source lobby phone number - E

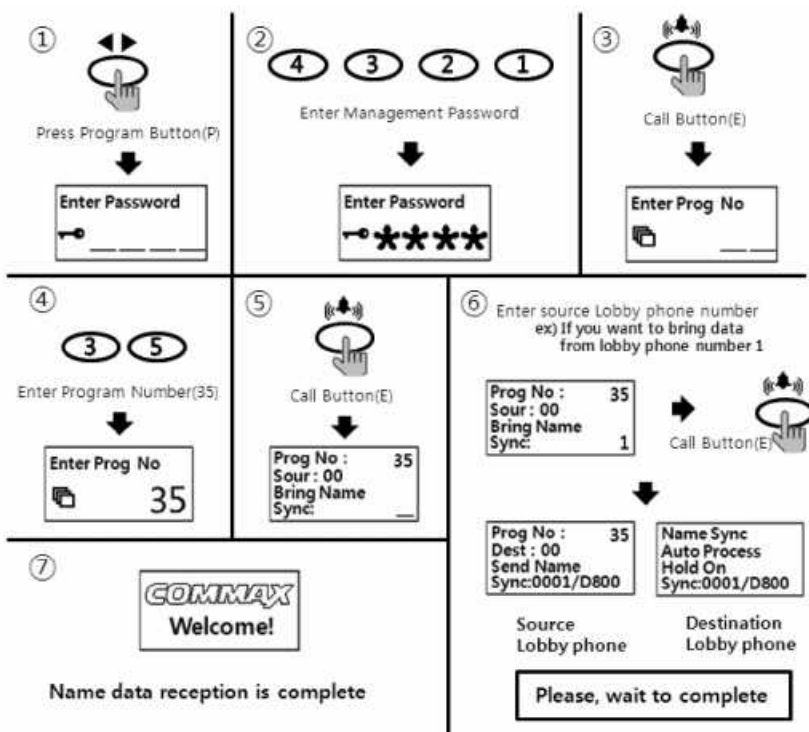

- ① Press Program Button "P".
- ② Press Management Password.
- ③ Press Call Button "E".
- ④ Press number "35" (setting number of name data)
- ⑤ Press Call Button "E".
- ⑥ Press number "source lobby phone number".
- ⑦ Press Call Button "E".

<References>

- Data can be received only if the mode "99" in the program number(23) is selected & executed the process within 30 seconds.
- You cannot use any other function before it completes(It takes about 5 minutes). If you want to complete more quickly, use the download program.



27. Setting the door release by building password

27-1. Setting the Door Release by Building Password

- P – Management Password – E – 28 – 1 – E : Door release by Building Password enabled.
- P – Management Password – E – 28 – 0 – E : Door release by Building Password disabled.
- This function enables the door release by Building Password.
- This function provides least security to the access of the entrance since the password is being shared among number of people. Please keep the security of Building Password strictly and/or change the Building Password periodically.

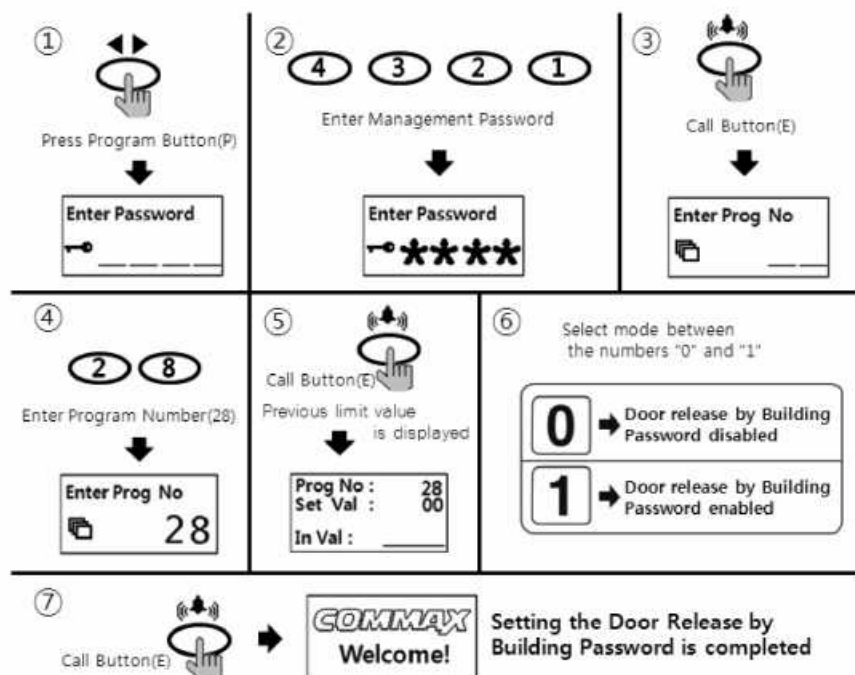

- ① Press Program Button "P".
- ② Enter Management Password.
- ③ Press Call Button "E".
- ④ Enter "28" (number twenty-eight).
- ⑤ Press Call Button "E".
- ⑥ Select mode between the numbers "0" and "1".
(1 : Door release by Building Password enabled)
(0 : Door release by Building Password disabled)
- ⑦ Press Call Button "E".

27-2. Using a door release by Building Password function.

- ① Press Call Button "E"

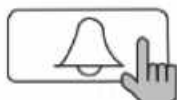

Call Button(E)

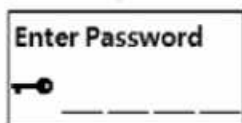

- ② Enter Building Password

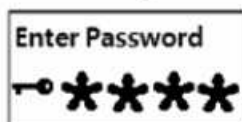

- ③ Door released

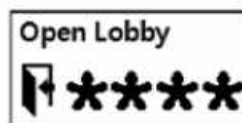



28. When you want to call a household

1) called to a household

① Enter the Unit Number that you wish to call

② Press Call Button "E"

③ Talk as answered

1) called to a household

① Press the button of searching name

② Searching the name by pressing the shift key button

③ If the name is not on this page, keep searching in progress pressing the page flip button

④ Press the call button & will hear ring tone

⑤ Speak to them if the household answers



29. When you want to call a Guard Station

- ① Press the button of searching name



- ② Press the Call button on the Guard tag & will hear ring tone

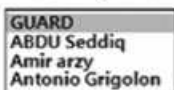

Call Button(E)

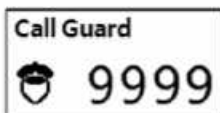

- ③ Speak to them if the guard answers

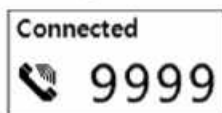

30. Door Release by Unit Password

- ① Enter the Unit Number



- ② Press "Key" Button

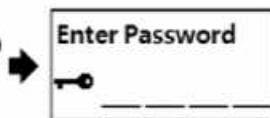

- ③ Enter the Unit Password

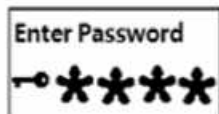

- ④ Press Call Button "E"



Call Button(E)

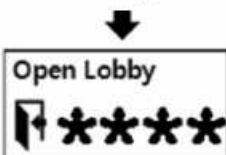



31. Supplement (summary of various programs)

Setting Passwords

1. P-Previous Management Password-E-0-E- New Management Password-E : Management Password Registration.
2. P-Previous Building Password-E-1-E-New Building Password-E : Building Password Registration
3. K-20-E-Household Unit Number-E-Previous Unit Password-E-New Unit Password-E : Unit Password Registration
4. P-Management Password-E-16-E-Unit Number-E : Retrieving Unit Password

Retrieving Unit Information

1. P-Management Password-E-14-E : Checking the unit's interphone status
2. P-Management Password-E-15-E : Unit Number Registration

Building number, Lobby phone number, and Door release function Settings

1. P-Management Password-E-2-E-Building Number-E : Building Number Registration
2. P-Management Password-E-3-E-Lobby Phone Number-E : Lobby Phone Number Registration
3. P-Management Password-E-28-E : Door Release Function enabled/disabled (00: Disabled, 01: Enabled)
4. P-Management Password-E-31-E : Electronic Key (Password) enabled/disabled (00: Disabled, 01: Enabled)

RF Card Key Programming

1. P-Management Password-E-9-E : RF Card Key Tesing
2. P-Management Password-E-10-E : RF Card Key Registration
3. P-Management Password-E-11-E : All RF Card Keys Initialization
4. P-Management Password-E-12-E : Deletion an individual RF Card Key
5. P-Management Password-E-13-E : RF Card Key Registration Confirmation
6. P-Management Password-E-32-E-Destination-E : RF Card Key Data Transmission
7. P-Management Password-E-33-E-Destination-E : RF Card Key Data Reception

Name Data Management

1. P-Management Password-E-34-E-Destination-E : Name Data Transmission
2. P-Management Password-E-35-E-Destination-E : Name Data Reception

SecuMAX Management

1. P-Management Password-E-18-E : Set to Door release by external information forwarding to SecuMAX.
2. P-Management Password-E-22-E : Set to Door release by internal information forwarding to SecuMAX.
3. P-Management Password-E-29-E : Set to be forced opening the Main Entrance door by SecuMAX.

Door Release by Password

1. Unit Number-K-Unit Password-E : by Unit Password.
2. E-Building Password : by Building Password

How to make a unit call and guard station call from a lobby phone

1. Press house number-E : to Household
2. S-Name Search-E : to Household
3. Press Number '9999'-E : to Guard Station
4. Name search-Select Guard-E : to Guard Station

Other settings

1. P-Management Password -E-5-E : Door Release Duration Setting
2. P-Management Password -E-6-E : Selecting Wiring Methods (04: Common 4 wires, 06: Common 6 wires)
3. P-Management Password -E-7-E : Selecting Call Rings (00:MELODY, 01:BELL)
4. P-Management Password -E-20-E : Setting the Keypad LED Option
(00 : Only work when you used lobby phone)
(01 : Always On)
5. P-Management Password -E-21-E : Setting the Call by Unit Line
6. P-Management password-E-24-E : Setting the time to trigger the notice to be forced door forwarding to SecuMAX
7. P-Management Password -E-25-E : Setting number of Call Rings
(00: continuous, 01: once)
8. P-Management password-E-27-E : Automatic calling function of guard station configuration
9. P-Management Password -E-30-Beep Volume-Voice Volume-E : Setting the Volume of Voice and Beep Sound

32. Wiring Information

1) Guard interphone

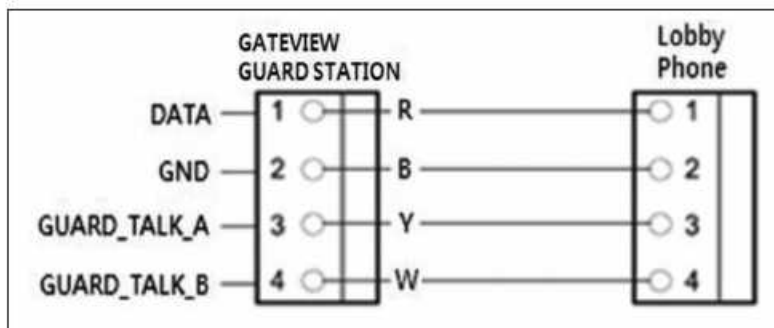

GateView GuardStation

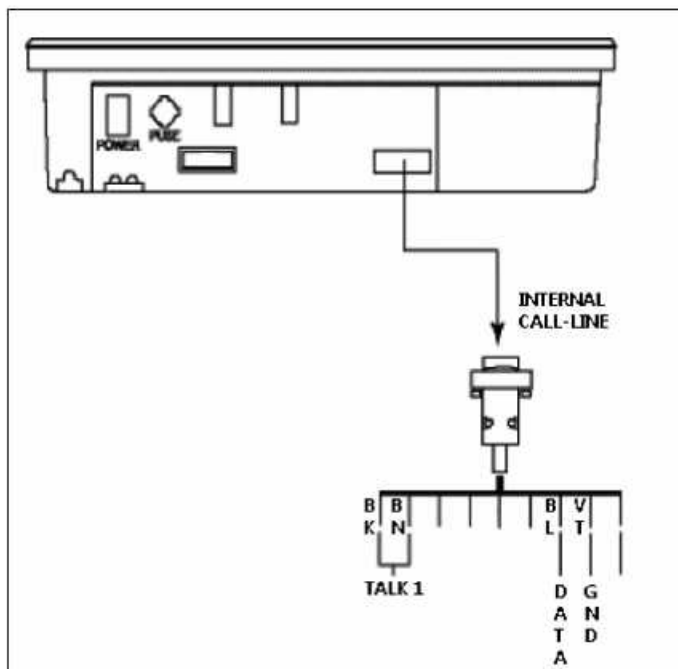

481 GuardStation

2) Sensor connection method

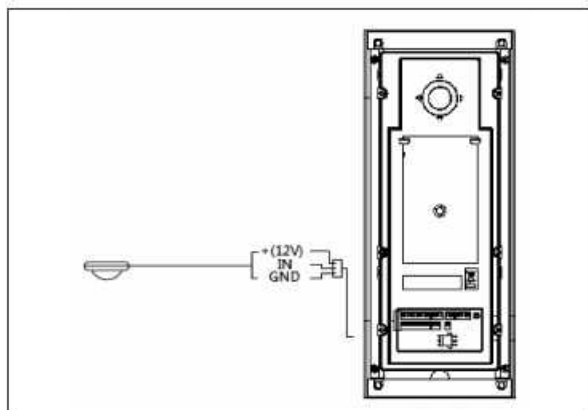

3) entrance interphone (DRC-GUC)

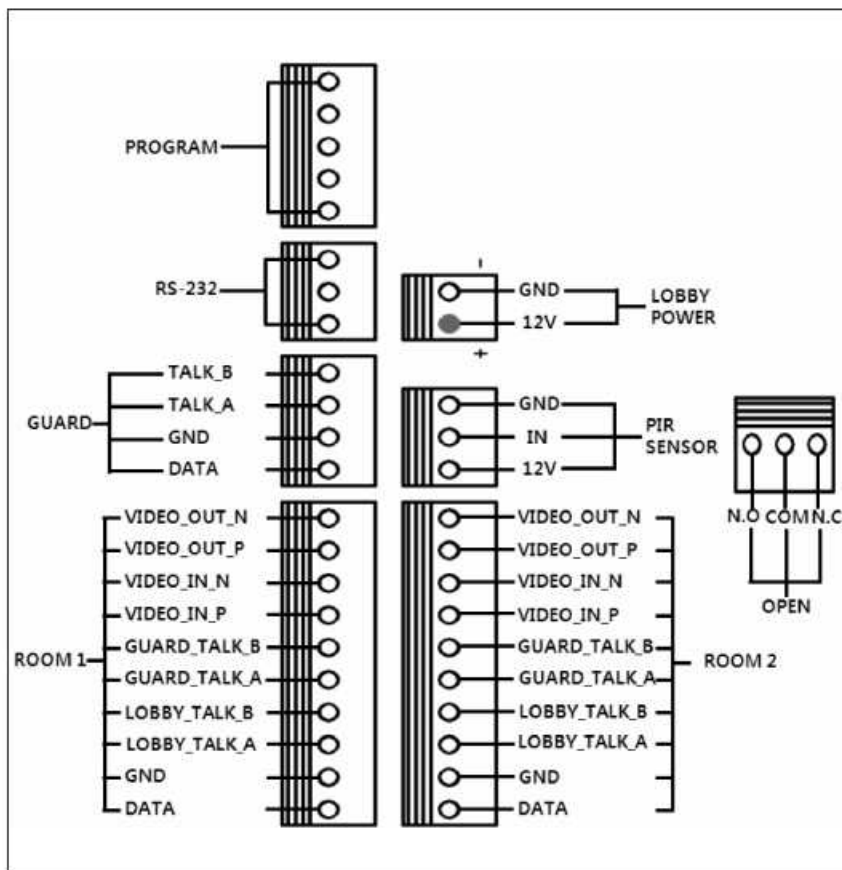

<Caution>

- If installed outdoor, it requires extra molding for water-proof and rainshield.

4) System schematic

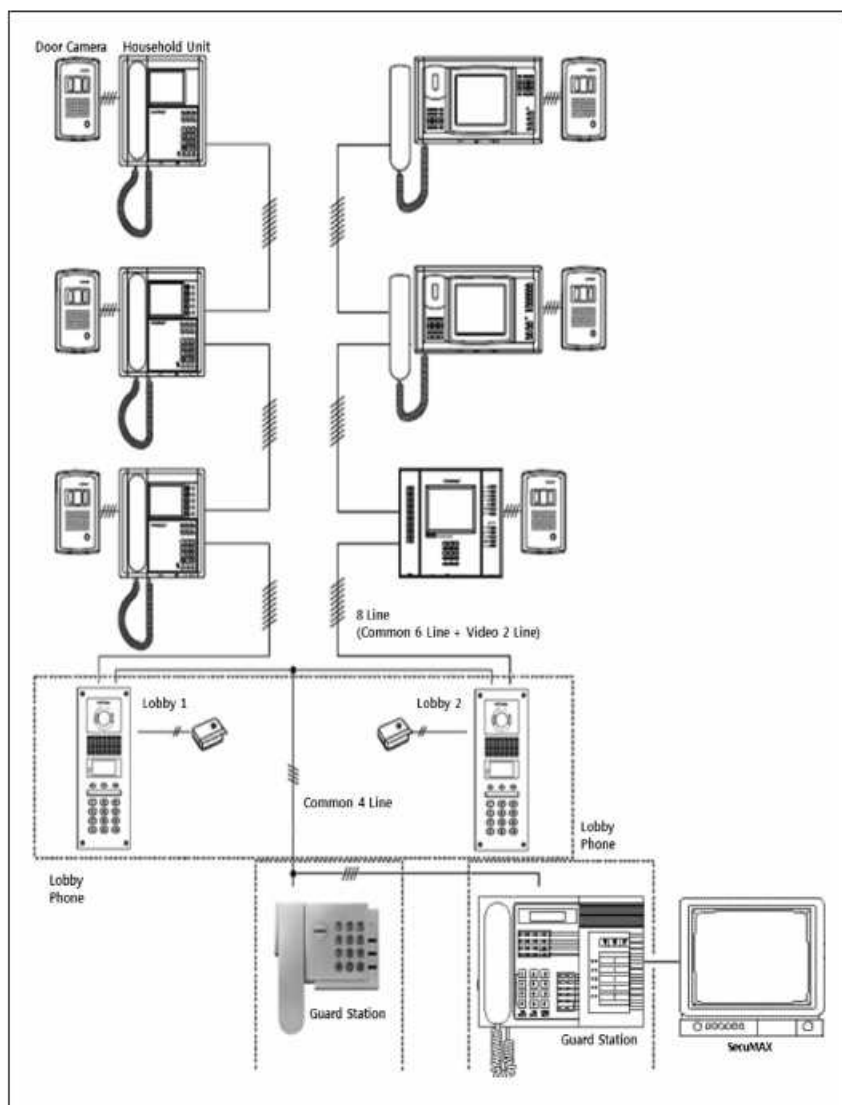

33. Miscellaneous

- Please carefully read this User's Guide before calling service man After checking the entire check list, please contact customer service center. We will do our best to make you satisfy with our services.

34. Part list

Item	Description	Q'ty
CONN. 2PX300	Wiring Connector	1
CONN.3P(3.96)X250	Wiring Connector	1
CONN.3PX300	Wiring Connector	2
CONN. 4PX300	Wiring Connector	1
CONN. 10PX300	Wiring Connector	2
POWER CODE	Adapter Connector	1
SCREW. FHM(WRENCH) 4*40 SUS Ni	Bracket + Flush Mount Bracket	4

35. Specifications and Features

Installation	Flush Mount Type installation
Model	DRC-GUC/RF1
Wiring	Gateview System (UTP Cable) Household unit monitor (8 wires-common 6 wires+video 2 wires), Security station phone (common 4 wires)
Power Source	DC 12V, 1A
Power Consumption	Standby : 135mA, Maximum : 320mA
Call Method	Handsfree (one way)
Image Sensor	Color CMOS
Horizontal/Vertical	15,735KHz / 60Hz,
Scanning Frequency	15,625KHz / 50Hz
Imaging Angle	Horizontal : 68 degrees, Vertical : 55 degrees
Lowest Intensity of Illumination	0.1 Lux (up to 300mm from the camera)
Effective Call Range	UTP CAT. 5e, 300m
RF Sensing Range	60mm
Lighting	Built-in LED light for night use
Temperature	-20°C(tested up to -40°C) ~ 40°C
Dimensions	130 (W) x 315 (H) x 40 (D) mm



36. RF-ID Model (Optional)

Communication Device Certification(RF Option)

Model Name	DRC-GUC/RF1
Frequency	13.56MHz
Antenna power range	Under 47.5mV/m within 10 meter radius
Power	DC 12V
Emission Type	A1D
Number of Channel	1 Channel
Modulation method	ASK
Communication method	Simplex Operation Method
Temperature	-10°C(tested up to -40°C) ~ +50°C, 95%



Memo



Memo

COMMAX

COMMAX Co.,Ltd.

513-11, Sangdaewon-dong, Jungwon-gu, Seongnam-si, Gyeonggi-do, Korea

Int'l Business Dept. Tel. : +82-31-7393-540~550 Fax. : +82-31-745-2133

Web site : www.commax.com

PM10GUCRF110

Printed in Korea / 2014.04.104